



FİYAT LİSTESİ

2023/1

*Fiyatlarımızdaki baskı ve dizgi aşamasında ortaya çıkabilecek sorunlarda "MERTİNOKS A.Ş." sorumlu değildir.
"MERTİNOKS A.Ş." fiyatlarda ve görsellerde her türlü değişiklik yapma hakkına sahiptir.*

iNDEX

YER SIFONLARI

04

DUŞ KANALLARI

22

DRENAJ KANALLARI

72

ENGELLİ SERİSİ

79

ÇÖP KOVALARI

85

WC FIRÇALIKLAR

101

DUŞ SETLERİ

105

AKSESUARLAR

112

İKON AÇIKLAMALARI



Yan Çıkış



File Montajlı



Alt Çıkış



Tekstil Membran Montajlı



İç Mekan



Bitüm Membran Montajlı



Dış Mekan



Düşük Yoğunluk Su Akışı



Sıcak - Soğuk Çalışma Ortamı



Yüksek Yoğunluk Su Akışı



Banyo (Islak Hacim)



Kilitli Sistem

YER SIFONLARI

EKO 10X10

Ürün Kodu	Kısa Kod	Çıkış	Ölçü	Fiyat	
YAN ÇIKIŞ					
3011.0Y050K.010.1	26583	Ø 50	10x10 cm	100	41.00

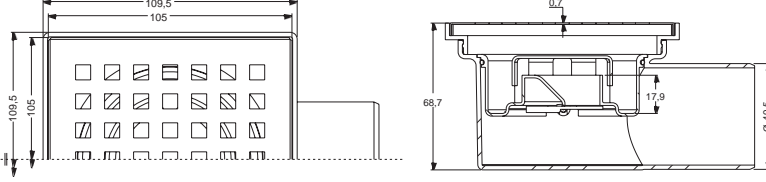

- Plastik gövde
- Paslanmaz ızgara
- Sulu koku tutucu

LINE 10x10

Ürün Kodu	Kısa Kod	Çıkış	Ölçü	Fiyat	
YAN ÇIKIŞ					
3012.0Y032K.010.1	13795	Ø 32	10x10 cm	160	49.00
3012.0Y040K.010.1	13800	Ø 40	10x10 cm	100	52.40
3012.0Y050K.010.1	13805	Ø 50	10x10 cm	100	53.00
3012.0Y070K.010.1	13812	Ø 70	10x10 cm	80	70.00
ALT ÇIKIŞ					
3012.0A040K.010.1	13818	Ø 40	10x10 cm	140	60.00
3012.0A050K.010.1	13826	Ø 50	10x10 cm	140	53.00
3012.0A070K.010.1	13832	Ø 70	10x10 cm	140	60.00
ELİTE LEGAL					
3012.0Y032K.010.B	28909	Ø 32	10x10 cm	40	90.00
3012.0Y050K.010.B	28910	Ø 50	10x10 cm	40	93.40

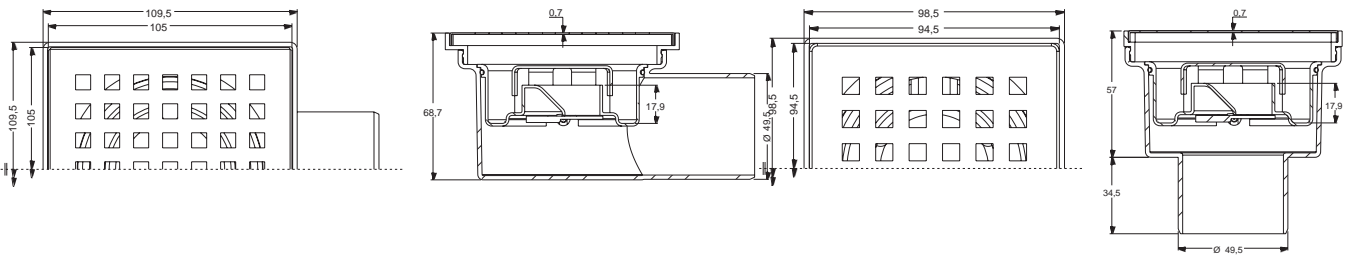

- Plastik gövde
- Paslanmaz ızgara
- Sulu koku tutucu
- Klepeli

Detaylar

DN 50 Yan ve Alt çıkış – Pvc boru bağlantılarına uyumludur. Akış hızı 32 lt/dk'dır. Iızgarası 304 kalite paslanmaz çeliktir.

Avantajlar

304 kalite paslanmaz çelik ızgarası sayesinde şık ve kaliteli bir görünüme sahiptir. Duvar dibi uygulamalarda rahatlıkla uygulanabilir. Su tutuculu koku önleyici sayesinde tesisattan gelecek kötü kokuları önler. Yükseltme ayakları sayesinde şapın yüksekliğine göre ayarlama olanağı sağlar. Organik ve inorganik kimyasallara yüksek dayanım. çoğu asidik ve tuzlu su oksidasyonuna dayanıklıdır.

Kullanım Alanları

Genel kullanım banyo duşları, hastane ve otel duş alanları, soyunma odaları duş alanları vb.

Özel Üretim

Iızgara modeli olarak isteğinize göre altın, bronz gibi renkler de üretilmektedir.

Uyarı

Yüksek yoğunluklu temizlik malzemelerinin uzun süreli kullanımı tavsiye edilmez.

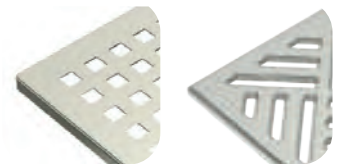

KARE

ENDEKS

LINE 15x15



- Plastik gövde
- Paslanmaz ızgara
- Sulu koku tutucu
- Klepeli

Ürün Kodu	Kısa Kod	Çıkış	Ölçü	Fiyat	
YAN ÇIKIŞ					
3012.0Y032K.015.1	13882	Ø 32	15x15 cm	80	92.70
3012.0Y040K.015.1	13888	Ø 40	15x15 cm	60	96.40
3012.0Y050K.015.1	13896	Ø 50	15x15 cm	60	97.00
3012.0Y070K.015.1	13903	Ø 70	15x15 cm	50	113.70
ALT ÇIKIŞ					
3012.0A040K.015.1	13911	Ø 40	15x15 cm	60	104.70
3012.0A050K.015.1	13926	Ø 50	15x15 cm	60	98.00
3012.0A070K.015.1	13933	Ø 70	15x15 cm	60	104.00

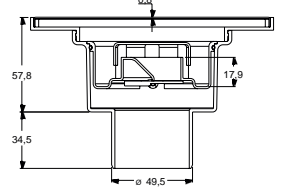
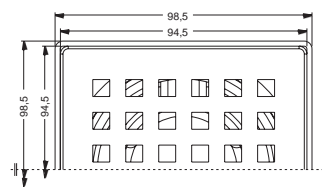
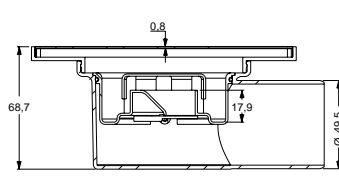
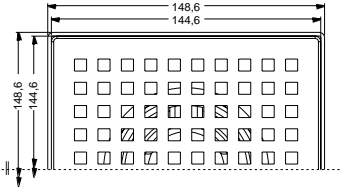

Detaylar

DN 50 Yan ve Alt çıkış – Pvc boru bağlantılarına uyumludur. Akış hızı 32 lt/dk'dır. Iızgarası 304 kalite paslanmaz çeliktir.

Avantajlar

304 kalite paslanmaz çelik ızgarası sayesinde şık ve kaliteli bir görünüme sahiptir. Duvar dibi uygulamalarda rahatlıkla uygulanabilir. Su tutuculu koku önleyici sayesinde tesisattan gelecek kötü kokuları önler. Yükseltme ayakları sayesinde şapın yüksekliğine göre ayarlama olanağı sağlar. Organik ve inorganik kimyasallara yüksek dayanım. çoğu asidik ve tuzlu su oksidasyonuna dayanıklıdır.

Kullanım Alanları

Genel kullanım banyo duşları, hastane ve otel duş alanları, soyunma odaları duş alanları vb.

Özel Üretim

Iızgara modeli olarak isteğinize göre altın, bronz gibi renkler de üretilmektedir.

Uyarı

Yüksek yoğunluklu temizlik malzemelerinin uzun süreli kullanımı tavsiye edilmez.



KARE



ENDEKS

YER SIFONLARI

LEGAL 10x10

Ürün Kodu	Kısa Kod	Çıkış	Ölçü	Fiyat	
YAN ÇIKIŞ					
3013.0Y032K.010.1	13940	Ø 32	10x10 cm	160	75.40
3013.0Y040K.010.1	13950	Ø 40	10x10 cm	100	78.70
3013.0Y050K.010.1	13960	Ø 50	10x10 cm	100	79.40
3013.0Y070K.010.1	13969	Ø 70	10x10 cm	80	96.00
ALT ÇIKIŞ					
3013.0A040K.010.1	13976	Ø 40	10x10 cm	140	85.70
3013.0A050K.010.1	13990	Ø 50	10x10 cm	140	79.40
3013.0A070K.010.1	13998	Ø 70	10x10 cm	140	85.00
ELİTE LEGAL					
3013.0Y032K.010.B	28911	Ø 32	10x10 cm	40	116.70
3013.0Y050K.010.B	28912	Ø 50	10x10 cm	40	120.00



- Plastik gövde
- Paslanmaz ızgara
- Sulu koku tutucu
- Klepeli

LEGAL 15x15

Ürün Kodu	Kısa Kod	Çıkış	Ölçü	Fiyat	
YAN ÇIKIŞ					
3013.0Y032K.015.1	13949	Ø 32	15x15 cm	80	138.00
3013.0Y040K.015.1	13968	Ø 40	15x15 cm	60	143.40
3013.0Y050K.015.1	13977	Ø 50	15x15 cm	60	143.40
3013.0Y070K.015.1	13981	Ø 70	15x15 cm	50	160.00
ALT ÇIKIŞ					
3013.0A040K.015.1	13989	Ø 40	15x15 cm	60	150.00
3013.0A050K.015.1	13996	Ø 50	15x15 cm	60	143.40
3013.0A070K.015.1	14006	Ø 70	15x15 cm	60	150.00



- Plastik gövde
- Paslanmaz ızgara
- Sulu koku tutucu
- Klepeli

Detaylar

DN 50 Yan ve Alt çıkış – Pvc boru bağlantılarına uyumludur. Akış hızı 32 lt/dk'dır. Iızgarası 304 kalite paslanmaz çeliktir.

Avantajlar

304 kalite paslanmaz çelik ızgarası sayesinde şık ve kaliteli bir görünüme sahiptir. Duvar dibi uygulamalarda rahatlıkla uygulanabilir. Su tutuculu koku önleyici sayesinde tesisattan gelecek kötü kokuları önler. Yükseltme ayakları sayesinde şapın yüksekliğine göre ayarlama olanağı sağlar. Organik ve inorganik kimyasallara yüksek dayanım. çoğu asidik ve tuzlu su oksidasyonuna dayanıklıdır.

Kullanım Alanları

Genel kullanım banyo duşları, hastane ve otel duş alanları, soyunma odaları duş alanları vb.

Özel Üretim

Iızgara modeli olarak isteğinize göre altın, bronz gibi renkler de üretilmektedir.

Uyarı

Yüksek yoğunluklu temizlik malzemelerinin uzun süreli kullanımı tavsiye edilmez.

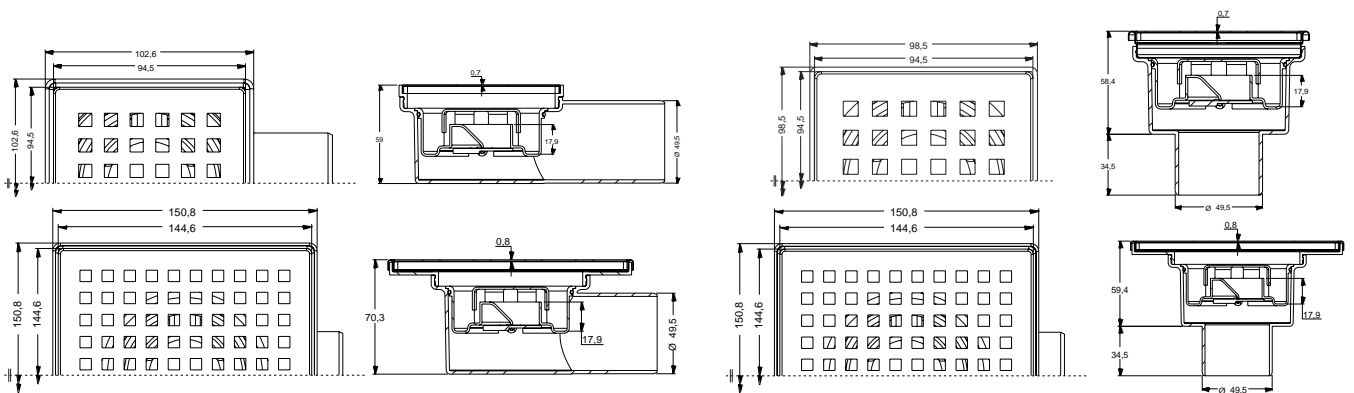

KARE



ENDEKS



- Plastik gövde
- Paslanmaz ızgara

KUCA

Ürün Kodu	Kısa Kod	Çıkış	Ölçü	Fiyat	
ALT ÇIKIŞ					
5710.0A050K.010.1	13939	Ø 50	10x10 cm	140	72.40
5710.0A070K.010.1	13941	Ø 70	10x10 cm	140	74.00

SCALA 10x10

Ürün Kodu	Kısa Kod	Çıkış	Ölçü	Fiyat	
YAN ÇIKIŞ					
3014.0Y032K.010.9	14005	Ø 32	10x10 cm	100	86.40
3014.0Y050K.010.9	14011	Ø 50	10x10 cm	100	89.70
ALT ÇIKIŞ					
3014.0A050K.010.9	14013	Ø 50	10x10 cm	120	88.70

- Plastik gövde
- Paslanmaz ızgara ve çerçeve
- Bariyerli koku tutucu

SCALA 15x15

Ürün Kodu	Kısa Kod	Çıkış	Ölçü	Fiyat	
YAN ÇIKIŞ					
3014.0Y032K.015.9	14014	Ø 32	15x15 cm	60	117.70
3014.0Y050K.015.9	14015	Ø 50	15x15 cm	60	119.00
ALT ÇIKIŞ					
3014.0A050K.015.9	14017	Ø 50	15x15 cm	60	120.70

- Plastik gövde
- Paslanmaz ızgara
- Sulu klepeli koku tutucu

KÖŞE BALKON

Ürün Kodu	Kısa Kod	Çıkış	Fiyat	
Ø70				
6001.0A070.13.0	13942	Ø 70	100	86.70
Ø100				
6002.0A100.16.0	13945	Ø 100	64	96.70

- Plastik gövde

MIDI 10X10

Ürün Kodu	Kısa Kod	Çıkış	Ölçü		Fiyat
YAN ÇIKIŞ					
5001.0Y032.010.1	14010	Ø 32	10x10 cm	80	83.70
5001.0Y040.010.1	14018	Ø 40	10x10 cm	60	87.40
5001.0Y050.010.1	14022	Ø 50	10x10 cm	60	88.00
5001.0Y070.010.1	14025	Ø 70	10x10 cm	50	110.70
ALT ÇIKIŞ					
5001.0A040.010.1	14032	Ø 40	10x10 cm	50	97.00
5001.0A050.010.1	14035	Ø 50	10x10 cm	50	90.70
5001.0A070.010.1	14039	Ø 70	10x10 cm	50	96.40



- Plastik gövde
- Paslanmaz ızgara
- Sulu koku tutucu
- Klepeli

STD. 10x10

Ürün Kodu	Kısa Kod	Çıkış	Ölçü		Fiyat
YAN ÇIKIŞ					
5002.0Y032.010.1	14019	Ø 32	10x10 cm	30	127.70
5002.0Y040.010.1	14041	Ø 40	10x10 cm	50	122.00
5002.0Y050.010.1	14046	Ø 50	10x10 cm	50	118.00
5002.0Y070.010.1	14050	Ø 70	10x10 cm	40	130.70
5002.0Y100.010.1	14052	Ø 100	10x10 cm	20	154.00
ALT ÇIKIŞ					
5002.0A040.010.1	14062	Ø 40	10x10 cm	50	119.00
5002.0A050.010.1	14067	Ø 50	10x10 cm	50	125.40
5002.0A070.010.1	14078	Ø 70	10x10 cm	50	119.70
5002.0A100.010.1	14083	Ø 100	10x10 cm	20	133.00



- Plastik gövde
- Paslanmaz ızgara
- Sulu koku tutucu
- Klepeli

STD. FİLELİ 10X10

Ürün Kodu	Kısa Kod	Çıkış	Ölçü		Fiyat
YAN ÇIKIŞ					
5002.FY032.010.1	14059	Ø 32	10x10 cm	60	131.40
5002.FY040.010.1	14055	Ø 40	10x10 cm	50	132.70
5002.FY050.010.1	14061	Ø 50	10x10 cm	50	128.70
5002.FY070.010.1	14068	Ø 70	10x10 cm	40	141.40
5002.FY100.010.1	14073	Ø 100	10x10 cm	20	163.00
ALT ÇIKIŞ					
5002.FA040.010.1	14077	Ø 40	10x10 cm	50	129.70
5002.FA050.010.1	14084	Ø 50	10x10 cm	50	130.40
5002.FA070.010.1	14088	Ø 70	10x10 cm	40	132.40
5002.FA100.010.1	14093	Ø 100	10x10 cm	40	132.70



- Plastik gövde
- Paslanmaz ızgara
- Fileli
- Sulu klepeli koku tutucu

STD. TEKSTİL MEMBRANLI 10X10

Ürün Kodu	Kısa Kod	Çıkış	Ölçü		Fiyat
YAN ÇIKIŞ					
5002.TY032.010.1	14091	Ø 32	10x10 cm	50	144.00
5002.TY040.010.1	14103	Ø 40	10x10 cm	50	144.00
5002.TY050.010.1	14107	Ø 50	10x10 cm	50	139.70
5002.TY070.010.1	14112	Ø 70	10x10 cm	40	153.00
5002.TY100.010.1	14120	Ø 100	10x10 cm	20	175.70
ALT ÇIKIŞ					
5002.TA040.010.1	14124	Ø 40	10x10 cm	50	141.00
5002.TA050.010.1	14128	Ø 50	10x10 cm	50	141.70
5002.TA070.010.1	14132	Ø 70	10x10 cm	40	143.70
5002.TA100.010.1	14136	Ø 100	10x10 cm	40	144.00

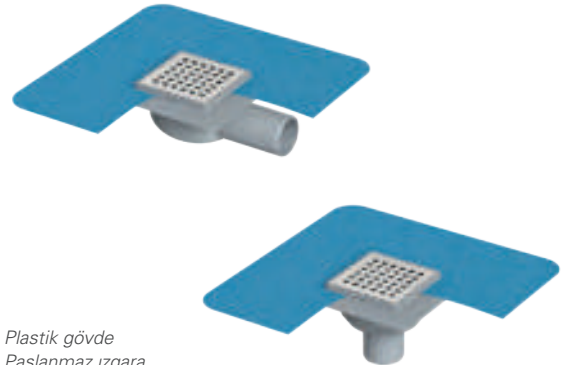

- Plastik gövde
- Paslanmaz ızgara
- Tekstil membranlı
- Sulu klepeli koku tutucu

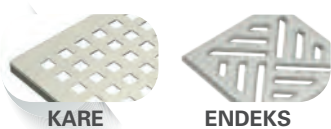

KARE

ENDEKS

PREMIUM 10x10



Ürün Kodu	Kısa Kod	Çıkış	Ölçü		Fiyat
YAN ÇIKIŞ					
3045.0Y032K.010.1	14096	Ø 32	10x10 cm	24	273.40
3045.0Y050K.010.1	14097	Ø 50	10x10 cm	24	300.00
ALT ÇIKIŞ					
3045.0A050K.010.1	14099	Ø 50	10x10 cm	24	280.00

- Paslanmaz gövde
- Paslanmaz ızgara
- Paslanmaz koku tutucu

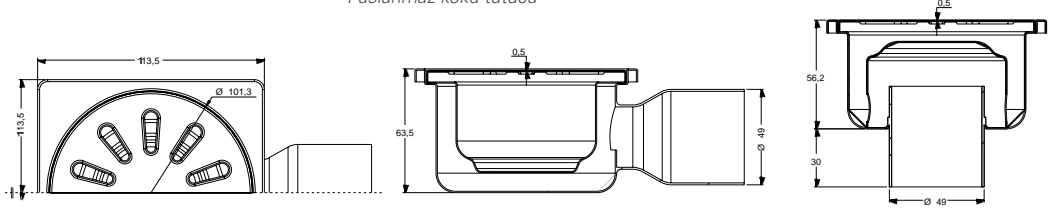

PREMIUM 15X15



Ürün Kodu	Kısa Kod	Çıkış	Ölçü		Fiyat
YAN ÇIKIŞ					
3045.0Y032K.015.1	14100	Ø 32	15x15 cm	24	306.70
3045.0Y050K.015.1	14102	Ø 50	15x15 cm	24	330.00
3045.0Y070K.015.1	14104	Ø 70	15x15 cm	24	350.00
ALT ÇIKIŞ					
3045.0A050K.015.1	14108	Ø 50	15x15 cm	24	313.40
3045.0A070K.015.1	14111	Ø 70	15x15 cm	24	353.40

- Paslanmaz gövde
- Paslanmaz ızgara
- Paslanmaz koku tutucu

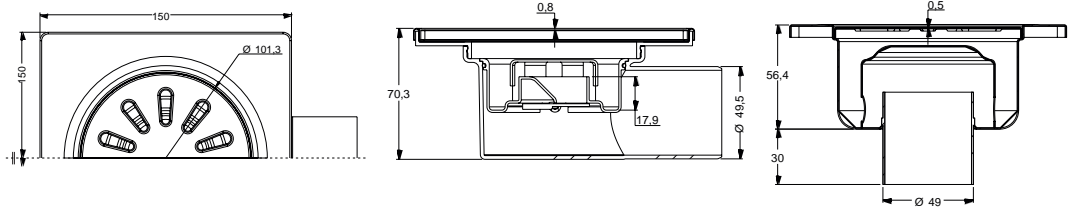

PREMIUM 20x20



Ürün Kodu	Kısa Kod	Çıkış	Ölçü		Fiyat
YAN ÇIKIŞ					
3045.0Y070K.020.1	14115	Ø 70	20x20 cm	12	1386.70
3045.0Y100K.020.1	14116	Ø 100	20x20 cm	12	1463.40
ALT ÇIKIŞ					
3045.0A070K.020.1	14117	Ø 70	20x20 cm	12	1373.40
3045.0A100K.020.1	14119	Ø 100	20x20 cm	12	1490.00

- Paslanmaz gövde
- Paslanmaz ızgara
- Paslanmaz koku tutucu

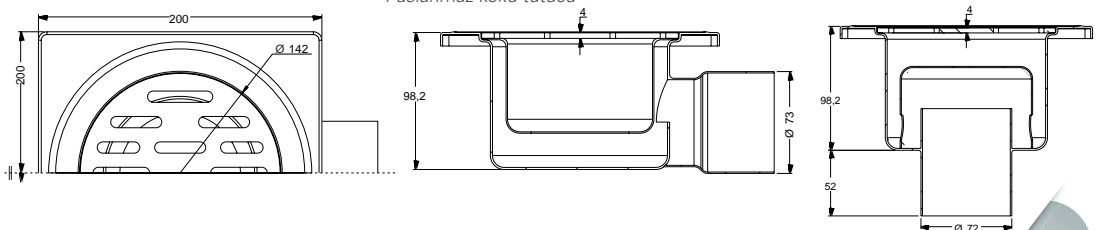

SIFON ÜST GÖVDE

LINE

Ürün Kodu	Kısa Kod	Çıkış	Ölçü	Fiyat
10X10				
5101.0A100.10.1	14198	Ø 100	10x10 cm	150 86.70
15X15				
5107.0A100.15.1	14200	Ø 100	15x15 cm	80 143.40

- Plastik gövde
- Paslanmaz ızgara
- Sulu klepelî koku tutucu



LEGAL

Ürün Kodu	Kısa Kod	Çıkış	Ölçü	Fiyat
10X10				
5102.0A100.10.1	14204	Ø 100	10x10 cm	150 123.40
15X15				
5108.0A100.15.1	14206	Ø 100	15x15 cm	80 186.70

- Plastik gövde
- Paslanmaz ızgara
- Sulu klepelî koku tutucu



PREMIUM

Ürün Kodu	Kısa Kod	Çıkış	Ölçü	Fiyat
10X10				
5105.0A100.10.0	14207	Ø 100	10x10 cm	120 146.70
15X15				
5111.0A100.15.0	14209	Ø 100	15x15 cm	80 180.00

- Plastik gövde
- Paslanmaz ızgara
- Sulu klepelî koku tutucu

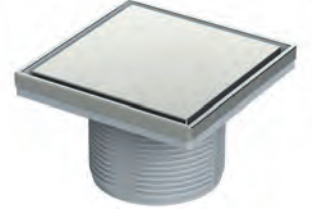

RING

Ürün Kodu	Kısa Kod	Çıkış	Fiyat
RING			
1207001100100	14208	Ø 100	150 33.40
IZGARALI RING			
5112.0A100.00.1	14210	Ø 100	150 93.40



• Yükseltme ara parçası



- Plastik gövde
- Paslanmaz ızgara
- Sulu klepelî koku tutucu



KARE



ENDEKS



SCALA 10X10

Ürün Kodu	Kısa Kod	Çıkış	Ölçü	Fiyat
ALT ÇIKIŞ				
5103.0A100.10.0	14199	Ø 100	10x10 cm	120

• Plastik gövde
• Sulu klepeli koku tutucu

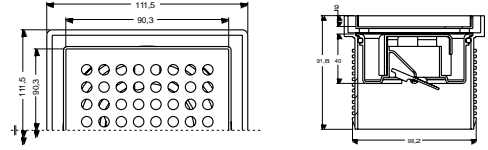

SCALA 15X15

Ürün Kodu	Kısa Kod	Çıkış	Ölçü	Fiyat
ALT ÇIKIŞ				
5109.0A100.15.0	14202	Ø 100	15x15 cm	80

• Plastik gövde
• Sulu klepeli koku tutucu

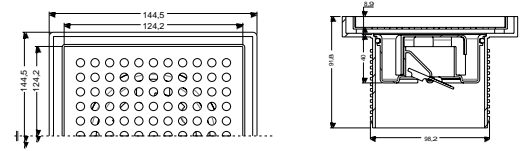

ELİT 10x10

Ürün Kodu	Kısa Kod	Çıkış	Ölçü	Fiyat
ALT ÇIKIŞ				
5104.0A100.10.0	14203	Ø 100	10x10 cm	120

• Plastik gövde
• Paslanmaz ızgara
• Sulu klepeli koku tutucu

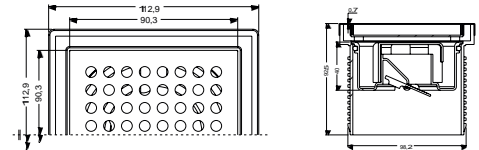

ELİT 15x15

Ürün Kodu	Kısa Kod	Çıkış	Ölçü	Fiyat
ALT ÇIKIŞ				
5110.0A100.15.0	14205	Ø 100	15x15 cm	80

• Plastik gövde
• Paslanmaz ızgara
• Sulu klepeli koku tutucu

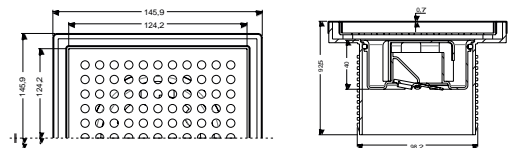

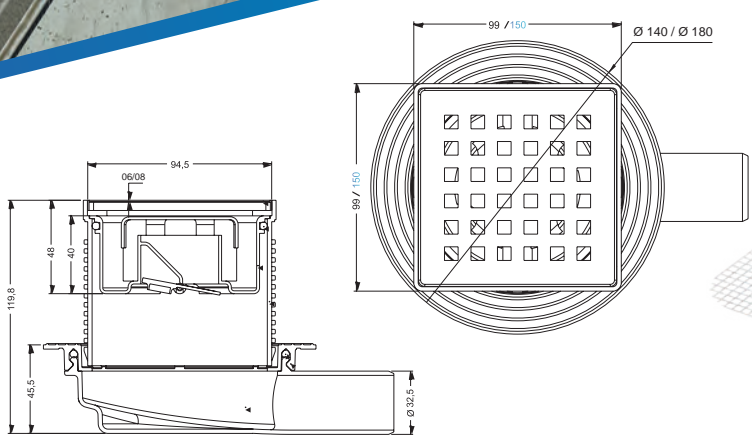
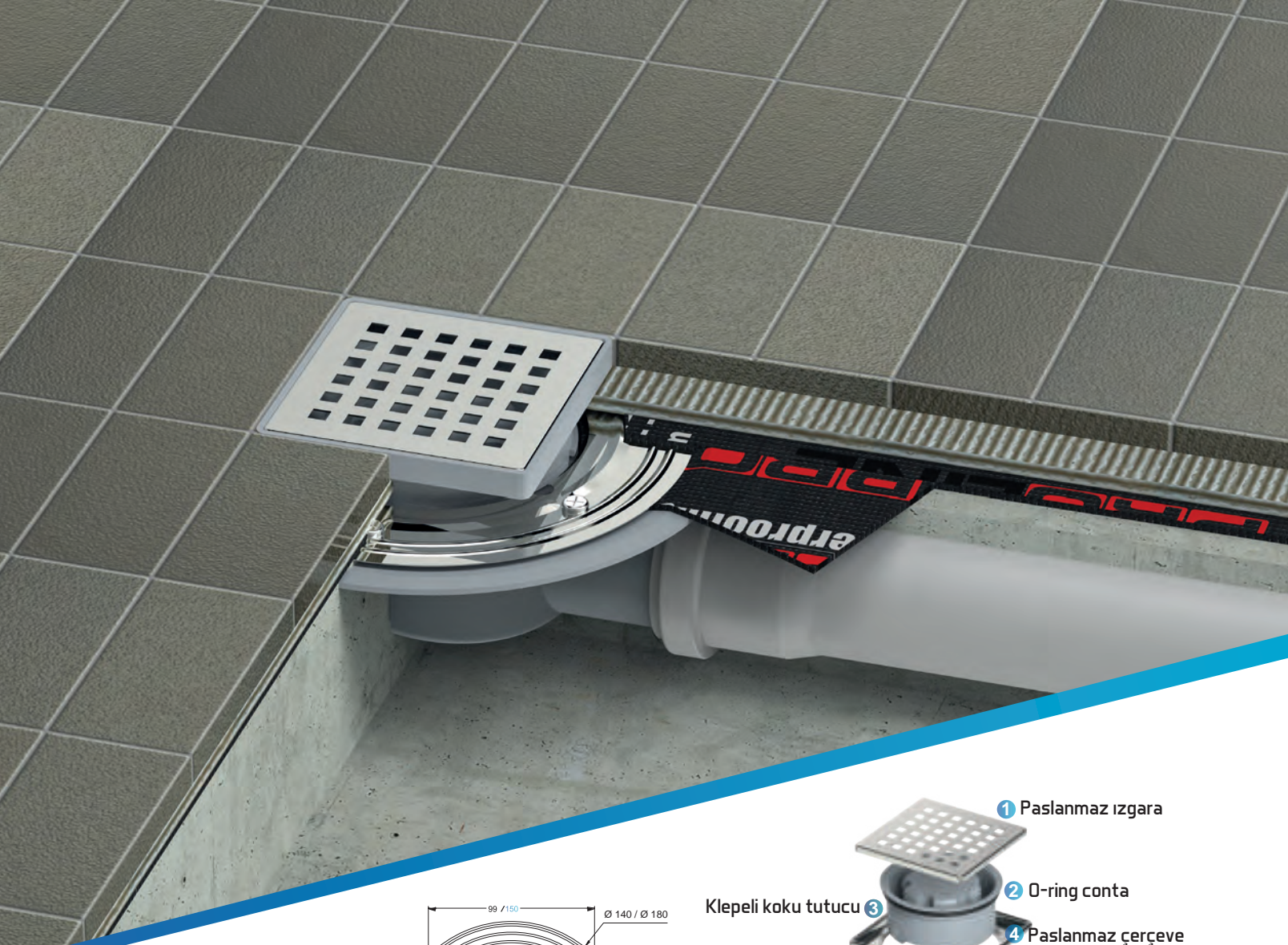

Ø 32 YAN ÇIKIŞ

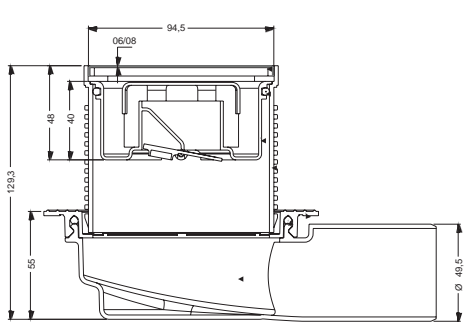

Ø 50 YAN ÇIKIŞ

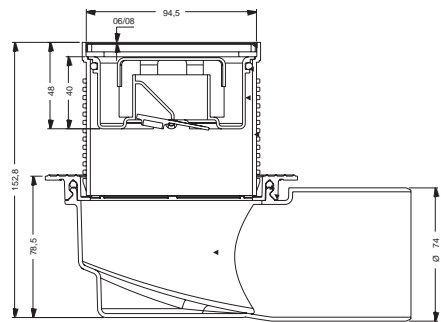

Ø 70 YAN ÇIKIŞ

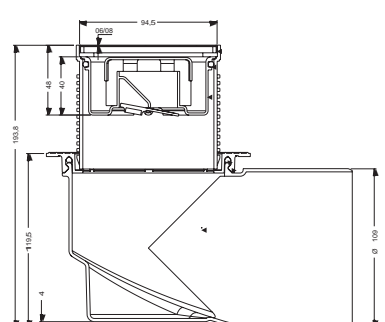

Ø 100 YAN ÇIKIŞ

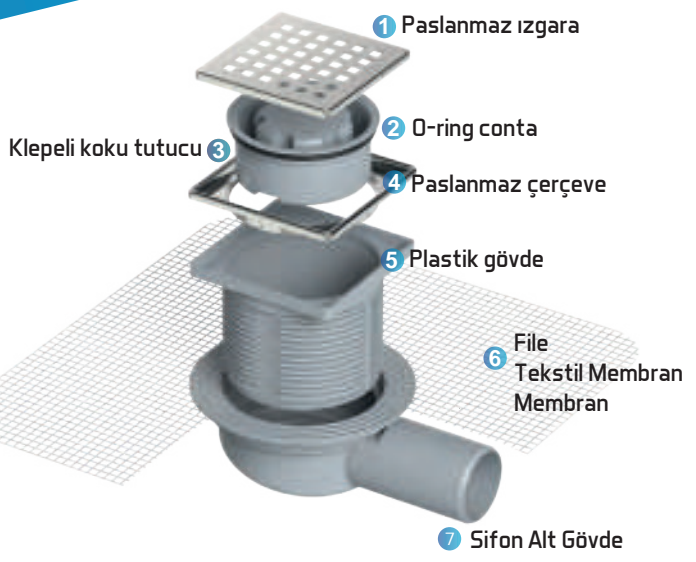

SİFON ALT GÖVDE

140MM DUVAR DİBİ



Ürün Kodu	Kısa Kod	Çıkış	Yükseklik	Fiyat
YAN ÇIKIŞ				
5014.0Y032.00.0	14212	Ø 32	46 mm	53.40
5014.0Y040.00.0	14213	Ø 40	55 mm	53.40
5014.0Y050.00.0	14215	Ø 50	55 mm	56.70
5014.0Y070.00.0	14224	Ø 70	79 mm	63.40
5014.0Y100.00.0	14225	Ø 100	115 mm	76.70
ALT ÇIKIŞ				
5014.0A040.00.0	14226	Ø 40	96 mm	50.00
5014.0A050.00.0	14227	Ø 50	96 mm	50.00
5014.0A070.00.0	14228	Ø 70	96 mm	53.40
5014.0A100.00.0	14229	Ø 100	96 mm	56.70

- Sifon alt gövde
- 140 mm flanşlı

180MM



Ürün Kodu	Kısa Kod	Çıkış	Yükseklik	Fiyat
YAN ÇIKIŞ				
5018.0Y032.00.0	14211	Ø 32	46 mm	60.00
5018.0Y040.00.0	14214	Ø 40	55 mm	60.00
5018.0Y050.00.0	14216	Ø 50	55 mm	60.00
5018.0Y070.00.0	14217	Ø 70	79 mm	70.00
5018.0Y100.00.0	14218	Ø 100	115 mm	93.40
ALT ÇIKIŞ				
5018.0A040.00.0	14219	Ø 40	96 mm	56.70
5018.0A050.00.0	14220	Ø 50	96 mm	56.70
5018.0A070.00.0	14221	Ø 70	96 mm	60.00
5018.0A100.00.0	14222	Ø 100	96 mm	60.00

- Sifon alt gövde
- 180 mm flanşlı

210MM



Ürün Kodu	Kısa Kod	Çıkış	Yükseklik	Fiyat
YAN ÇIKIŞ				
5021.0Y032.00.0	14231	Ø 32	46 mm	70.00
5021.0Y040.00.0	14232	Ø 40	55 mm	70.00
5021.0Y050.00.0	14233	Ø 50	55 mm	73.40
5021.0Y070.00.0	14234	Ø 70	79 mm	80.00
5021.0Y100.00.0	14236	Ø 100	115 mm	103.40
ALT ÇIKIŞ				
5021.0A040.00.0	14237	Ø 40	96 mm	70.00
5021.0A050.00.0	14239	Ø 50	96 mm	70.00
5021.0A070.00.0	14241	Ø 70	96 mm	70.00
5021.0A100.00.0	14243	Ø 100	96 mm	73.40

- Sifon alt gövde
- 210 mm flanşlı

SIFON ALT GÖVDE

140 MM FİLELİ

Ürün Kodu	Kısa Kod	Çıkış	Yükseklik	Fiyat	
YAN ÇIKIŞ					
5014.FY032.00.0	14230	Ø 32	46 mm	125	66.70
5014.FY040.00.0	14235	Ø 40	55 mm	125	66.70
5014.FY050.00.0	14238	Ø 50	55 mm	100	66.70
5014.FY070.00.0	14242	Ø 70	79 mm	75	76.70
5014.FY100.00.0	14244	Ø 100	115 mm	75	86.70
ALT ÇIKIŞ					
5014.FA040.00.0	14246	Ø 40	96 mm	100	63.40
5014.FA050.00.0	14247	Ø 50	96 mm	100	63.40
5014.FA070.00.0	14248	Ø 70	96 mm	75	66.70
5014.FA100.00.0	14249	Ø 100	96 mm	75	66.70

- Sifon alt gövde
- 140 mm fileli flanşlı

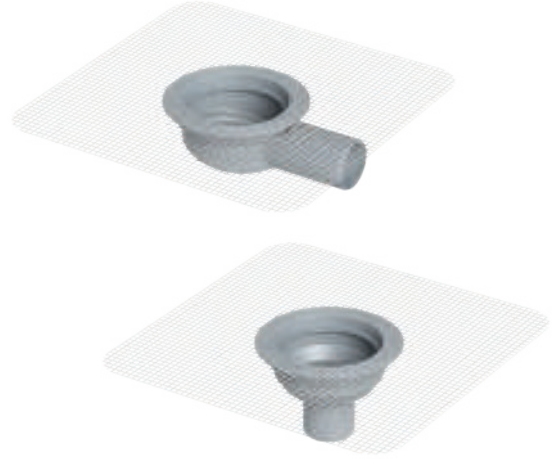

180MM FİLELİ

Ürün Kodu	Kısa Kod	Çıkış	Yükseklik	Fiyat	
YAN ÇIKIŞ					
5018.FY032.00.0	14245	Ø 32	46 mm	100	70.00
5018.FY040.00.0	14250	Ø 40	55 mm	100	70.00
5018.FY050.00.0	14251	Ø 50	55 mm	100	70.00
5018.FY070.00.0	14253	Ø 70	79 mm	75	80.00
5018.FY100.00.0	14255	Ø 100	115 mm	72	90.00
ALT ÇIKIŞ					
5018.FA040.00.0	14262	Ø 40	96 mm	100	66.70
5018.FA050.00.0	14265	Ø 50	96 mm	90	70.00
5018.FA070.00.0	14266	Ø 70	96 mm	85	70.00
5018.FA100.00.0	14267	Ø 100	96 mm	72	70.00

- Sifon alt gövde
- 180 mm fileli flanşlı

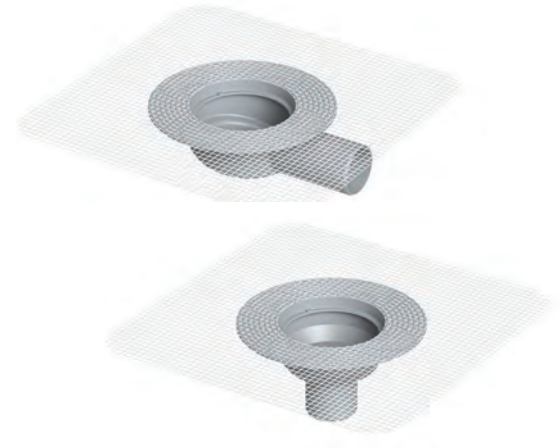

140MM T. MEMBRANLI

Ürün Kodu	Kısa Kod	Çıkış	Yükseklik	Fiyat	
YAN ÇIKIŞ					
5014.TY032.00.0	14252	Ø 32	46 mm	125	73.40
5014.TY040.00.0	14254	Ø 40	55 mm	125	73.40
5014.TY050.00.0	14256	Ø 50	55 mm	100	76.70
5014.TY070.00.0	14257	Ø 70	79 mm	75	86.70
5014.TY100.00.0	14258	Ø 100	115 mm	75	96.70
ALT ÇIKIŞ					
5014.TA040.00.0	14259	Ø 40	96 mm	100	73.40
5014.TA050.00.0	14260	Ø 50	96 mm	100	73.40
5014.TA070.00.0	14261	Ø 70	96 mm	75	76.70
5014.TA100.00.0	14263	Ø 100	96 mm	75	76.70

- Sifon alt gövde
- 140 mm Tekstil Membranlı flanşlı

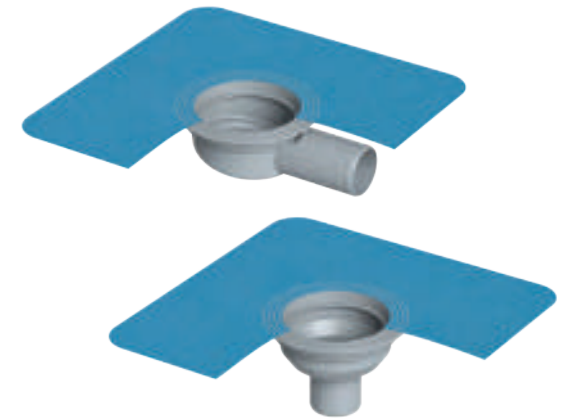

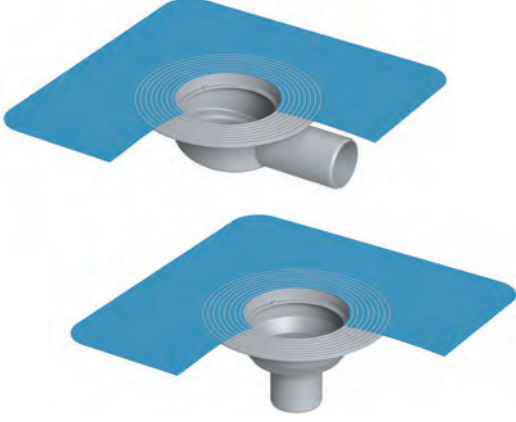

180 MM T.MEMBRANLI

Ürün Kodu	Kısa Kod	Çıkış	Yükseklik	Fiyat	
YAN ÇIKIŞ					
5018.TY032.00.0	14264	Ø 32	46 mm	100	80.00
5018.TY040.00.0	14268	Ø 40	55 mm	100	80.00
5018.TY050.00.0	14270	Ø 50	55 mm	90	83.40
5018.TY070.00.0	14271	Ø 70	79 mm	75	90.00
5018.TY100.00.0	14272	Ø 100	115 mm	50	106.70
ALT ÇIKIŞ					
5018.TA040.00.0	14273	Ø 40	96 mm	85	80.00
5018.TA050.00.0	14276	Ø 50	96 mm	85	80.00
5018.TA070.00.0	14278	Ø 70	96 mm	75	80.00
5018.TA100.00.0	14280	Ø 100	96 mm	75	80.00

- Sifon alt gövde
- 180 mm tekstil membranlı flanşlı



210 MM MEMBRANLI

Ürün Kodu	Kısa Kod	Çıkış	Yükseklik	Fiyat	
YAN ÇIKIŞ					
5021.MY032.00.0	14269	Ø 32	50 mm	35	170.00
5021.MY040.00.0	14274	Ø 40	59 mm	35	170.00
5021.MY050.00.0	14277	Ø 50	59 mm	35	170.00
5021.MY070.00.0	14279	Ø 70	84 mm	30	180.00
5021.MY100.00.0	14281	Ø 100	119 mm	30	193.40
ALT ÇIKIŞ					
5021.MA040.00.0	14283	Ø 40	100 mm	30	170.00
5021.MA050.00.0	14284	Ø 50	100 mm	30	170.00
5021.MA070.00.0	14285	Ø 70	100 mm	30	170.00
5021.MA100.00.0	14287	Ø 100	100 mm	30	173.40

- Paslanmaz gövde
- Paslanmaz flanş takımı
- Bitüm membranlı

ALT ÇIKIŞ ÖLÇÜLERİ

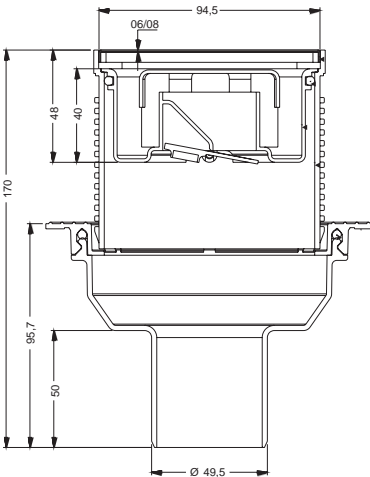

Ø 50 ALT ÇIKIŞ

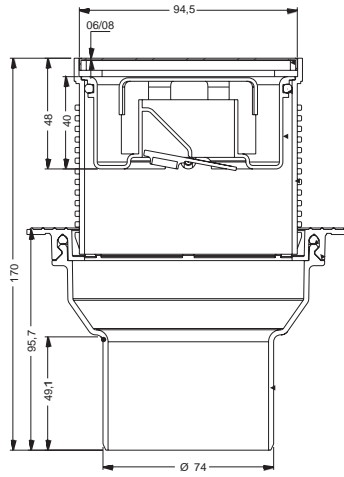

Ø 70 ALT ÇIKIŞ

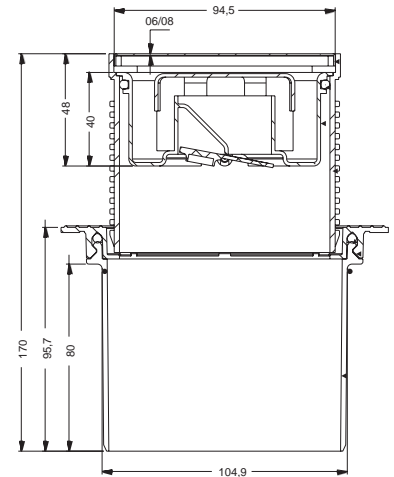

Ø 100 ALT ÇIKIŞ

140 MM 10x10 DUVAR DİBİ

Ürün Kodu	Kısa Kod	Çıkış	Ölçü		Fiyat
YAN ÇIKIŞ					
5054.0Y032.10.1	14282	Ø 32	10x10 cm	50	150.00
5054.0Y040.10.1	14286	Ø 40	10x10 cm	50	153.40
5054.0Y050.10.1	14289	Ø 50	10x10 cm	50	153.40
5054.0Y070.10.1	14290	Ø 70	10x10 cm	50	156.70
5054.0Y100.10.1	14291	Ø 100	10x10 cm	50	170.00
ALT ÇIKIŞ					
5054.0A040.10.1	14292	Ø 40	10x10 cm	50	150.00
5054.0A050.10.1	14293	Ø 50	10x10 cm	50	150.00
5054.0A070.10.1	14294	Ø 70	10x10 cm	50	150.00
5054.0A100.10.1	14295	Ø 100	10x10 cm	50	150.00

- Plastik gövde
- Paslanmaz ızgara
- Sulu klepelik koku tutucu
- 140 mm flanşlı



180MM 10X10

Ürün Kodu	Kısa Kod	Çıkış	Ölçü		Fiyat
YAN ÇIKIŞ					
5058.0Y032.10.1	14288	Ø 32	10x10 cm	50	156.70
5058.0Y040.10.1	14296	Ø 40	10x10 cm	50	156.70
5058.0Y050.10.1	14299	Ø 50	10x10 cm	50	156.70
5058.0Y070.10.1	14302	Ø 70	10x10 cm	50	163.40
5058.0Y100.10.1	14303	Ø 100	10x10 cm	50	173.40
ALT ÇIKIŞ					
5058.0A040.10.1	14305	Ø 40	10x10 cm	50	153.40
5058.0A050.10.1	14307	Ø 50	10x10 cm	50	153.40
5058.0A070.10.1	14309	Ø 70	10x10 cm	50	153.40
5058.0A100.10.1	14311	Ø 100	10x10 cm	50	153.40

- Plastik gövde
- Paslanmaz ızgara
- Sulu klepelik koku tutucu
- 180 mm flanşlı



180MM 15X15

Ürün Kodu	Kısa Kod	Çıkış	Ölçü		Fiyat
YAN ÇIKIŞ					
5058.0Y032.15.1	14298	Ø 32	15x15cm	50	206.70
5058.0Y040.15.1	14300	Ø 40	15x15cm	50	206.70
5058.0Y050.15.1	14301	Ø 50	15x15cm	50	206.70
5058.0Y070.15.1	14304	Ø 70	15x15cm	50	213.40
5058.0Y100.15.1	14306	Ø 100	15x15cm	50	223.40
ALT ÇIKIŞ					
5058.0A040.15.1	14308	Ø 40	15x15cm	50	203.40
5058.0A050.15.1	14310	Ø 50	15x15cm	50	203.40
5058.0A070.15.1	14312	Ø 70	15x15cm	50	203.40
5058.0A100.15.1	14314	Ø 100	15x15cm	50	203.40

- Plastik gövde
- Paslanmaz ızgara
- Sulu klepelik koku tutucu
- 180 mm flanşlı



140 MM 10x10 FİLELİ



Ürün Kodu	Kısa Kod	Çıkış	Ölçü	Fiyat
YAN ÇIKIŞ				
5054.FY032.10.1	14313	Ø 32	10x10 cm	163.40
5054.FY040.10.1	14319	Ø 40	10x10 cm	163.40
5054.FY050.10.1	14321	Ø 50	10x10 cm	163.40
5054.FY070.10.1	14322	Ø 70	10x10 cm	170.00
5054.FY100.10.1	14323	Ø 100	10x10 cm	180.00
ALT ÇIKIŞ				
5054.FA040.10.1	14324	Ø 40	10x10 cm	160.00
5054.FA050.10.1	14325	Ø 50	10x10 cm	160.00
5054.FA070.10.1	14326	Ø 70	10x10 cm	160.00
5054.FA100.10.1	14327	Ø 100	10x10 cm	160.00

- Plastik gövde
- Paslanmaz ızgara
- Sulu klepelili koku tutucu
- 140 mm fileli flanşlı

180 MM 10x10 FİLELİ



Ürün Kodu	Kısa Kod	Çıkış	Ölçü	Fiyat
YAN ÇIKIŞ				
5058.FY032.10.1	14315	Ø 32	10x10 cm	166.70
5058.FY040.10.1	14316	Ø 40	10x10 cm	166.70
5058.FY050.10.1	14317	Ø 50	10x10 cm	166.70
5058.FY070.10.1	14318	Ø 70	10x10 cm	173.40
5058.FY100.10.1	14320	Ø 100	10x10 cm	186.70
ALT ÇIKIŞ				
5058.FA040.10.1	14328	Ø 40	10x10 cm	163.40
5058.FA050.10.1	14330	Ø 50	10x10 cm	163.40
5058.FA070.10.1	14331	Ø 70	10x10 cm	163.40
5058.FA100.10.1	14332	Ø 100	10x10 cm	166.70

- Plastik gövde
- Paslanmaz ızgara
- Sulu klepelili koku tutucu
- 180 mm fileli flanşlı

180 MM 15x15 FİLELİ

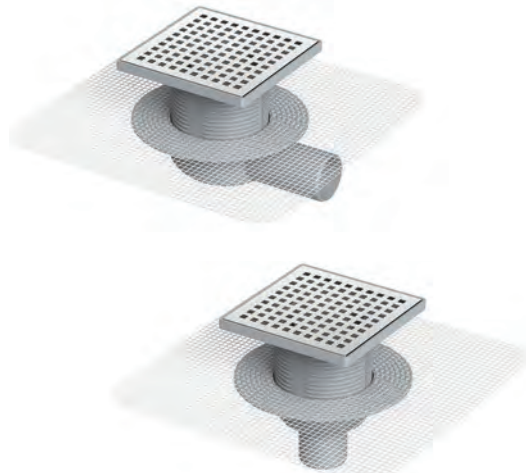

Ürün Kodu	Kısa Kod	Çıkış	Ölçü	Fiyat
YAN ÇIKIŞ				
5058.FY032.15.1	14333	Ø 32	15x15cm	216.70
5058.FY040.15.1	14334	Ø 40	15x15cm	216.70
5058.FY050.15.1	14335	Ø 50	15x15cm	216.70
5058.FY070.15.1	14336	Ø 70	15x15cm	223.40
5058.FY100.15.1	14337	Ø 100	15x15cm	233.40
ALT ÇIKIŞ				
5058.FA040.15.1	14338	Ø 40	15x15cm	213.40
5058.FA050.15.1	14340	Ø 50	15x15cm	213.40
5058.FA070.15.1	14341	Ø 70	15x15cm	213.40
5058.FA100.15.1	14344	Ø 100	15x15cm	213.40

- Plastik gövde
- Paslanmaz ızgara
- Sulu klepelili koku tutucu
- 180 mm fileli flanşlı

YALITIM UYUMLU SIFONLAR

140 MM 10x10 T.MEMBRANLI

Ürün Kodu	Kısa Kod	Çıkış	Ölçü		Fiyat
YAN ÇIKIŞ					
5054.TY032.10.1	14342	Ø 32	10x10 cm	50	170.70
5054.TY040.10.1	14346	Ø 40	10x10 cm	50	171.00
5054.TY050.10.1	14349	Ø 50	10x10 cm	50	171.40
5054.TY070.10.1	14351	Ø 70	10x10 cm	50	177.40
5054.TY100.10.1	14353	Ø 100	10x10 cm	50	189.40
ALT ÇIKIŞ					
5054.TA040.10.1	14356	Ø 40	10x10 cm	50	168.00
5054.TA050.10.1	14357	Ø 50	10x10 cm	50	168.70
5054.TA070.10.1	14359	Ø 70	10x10 cm	50	168.70
5054.TA100.10.1	14361	Ø 100	10x10 cm	50	169.00

- Plastik gövde
- Paslanmaz ızgara
- Sulu klepelili koku tutucu
- 140 mm tekstil membranlı flanşlı



180 MM 10x10 T.MEMBRANLI

Ürün Kodu	Kısa Kod	Çıkış	Ölçü		Fiyat
YAN ÇIKIŞ					
5058.TY032.10.1	14345	Ø 32	10x10 cm	50	176.70
5058.TY040.10.1	14348	Ø 40	10x10 cm	50	176.70
5058.TY050.10.1	14350	Ø 50	10x10 cm	50	176.70
5058.TY070.10.1	14352	Ø 70	10x10 cm	50	183.40
5058.TY100.10.1	14354	Ø 100	10x10 cm	50	196.70
ALT ÇIKIŞ					
5058.TA040.10.1	14355	Ø 40	10x10 cm	50	173.40
5058.TA050.10.1	14358	Ø 50	10x10 cm	50	173.40
5058.TA070.10.1	14360	Ø 70	10x10 cm	50	173.40
5058.TA100.10.1	14362	Ø 100	10x10 cm	50	176.70

- Plastik gövde
- Paslanmaz ızgara
- Sulu klepelili koku tutucu
- 180 mm tekstil membranlı flanşlı

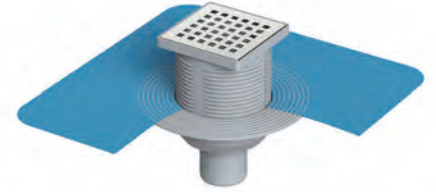
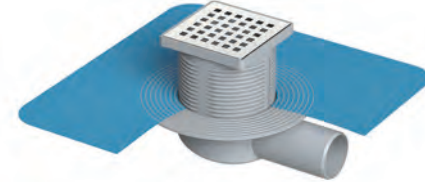

180 MM 15x15 T.MEMBRANLI

Ürün Kodu	Kısa Kod	Çıkış	Ölçü		Fiyat
YAN ÇIKIŞ					
5058.TY032.15.1	14364	Ø 32	15x15cm	50	230.00
5058.TY040.15.1	14365	Ø 40	15x15cm	50	230.00
5058.TY050.15.1	14366	Ø 50	15x15cm	50	230.00
5058.TY070.15.1	14367	Ø 70	15x15cm	50	236.70
5058.TY100.15.1	14368	Ø 100	15x15cm	50	260.00
ALT ÇIKIŞ					
5058.TA040.15.1	14369	Ø 40	15x15cm	50	240.00
5058.TA050.15.1	14370	Ø 50	15x15cm	50	240.00
5058.TA070.15.1	14371	Ø 70	15x15cm	50	240.00
5058.TA100.15.1	14372	Ø 100	15x15cm	50	240.00

- Plastik gövde
- Paslanmaz ızgara
- Sulu klepelili koku tutucu
- 180 mm tekstil membranlı flanşlı

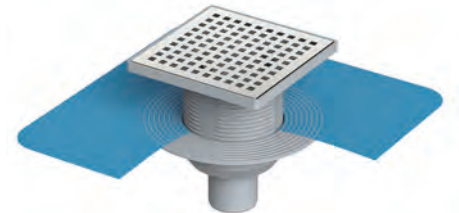
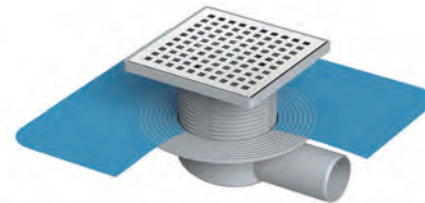



210 MM 10x10 MEMBRANLI

Ürün Kodu	Kısa Kod	Çıkış	Ölçü	Fiyat	
YAN ÇIKIŞ					
5061.MY032.10.1	14363	Ø 32	10x10 cm	20	300.00
5061.MY040.10.1	14373	Ø 40	10x10 cm	20	300.00
5061.MY050.10.1	14374	Ø 50	10x10 cm	20	300.00
5061.MY070.10.1	14375	Ø 70	10x10 cm	20	306.70
5061.MY100.10.1	14377	Ø 100	10x10 cm	10	320.00
ALT ÇIKIŞ					
5061.MA040.10.1	14378	Ø 40	10x10 cm	20	296.70
5061.MA050.10.1	14379	Ø 50	10x10 cm	20	296.70
5061.MA070.10.1	14380	Ø 70	10x10 cm	20	296.70
5061.MA100.10.1	14385	Ø 100	10x10 cm	10	296.70

- Plastik gövde
- Paslanmaz ızgara
- Sulu klepelî koku tutucu
- 210 mm bitüm membranlı



210 MM 15x15 MEMBRANLI

Ürün Kodu	Kısa Kod	Çıkış	Ölçü	Fiyat	
YAN ÇIKIŞ					
5061.MY032.15.1	14376	Ø 32	15x15cm	20	343.40
5061.MY040.15.1	14381	Ø 40	15x15cm	20	343.40
5061.MY050.15.1	14382	Ø 50	15x15cm	20	343.40
5061.MY070.15.1	14383	Ø 70	15x15cm	20	350.00
5061.MY100.15.1	14384	Ø 100	15x15cm	10	360.00
ALT ÇIKIŞ					
5061.MA040.15.1	14386	Ø 40	15x15cm	20	340.00
5061.MA050.15.1	14388	Ø 50	15x15cm	20	340.00
5061.MA070.15.1	14390	Ø 70	15x15cm	20	340.00
5061.MA100.15.1	14392	Ø 100	15x15cm	10	340.00

- Plastik gövde
- Paslanmaz ızgara
- Sulu klepelî koku tutucu
- 210 mm bitüm membranlı

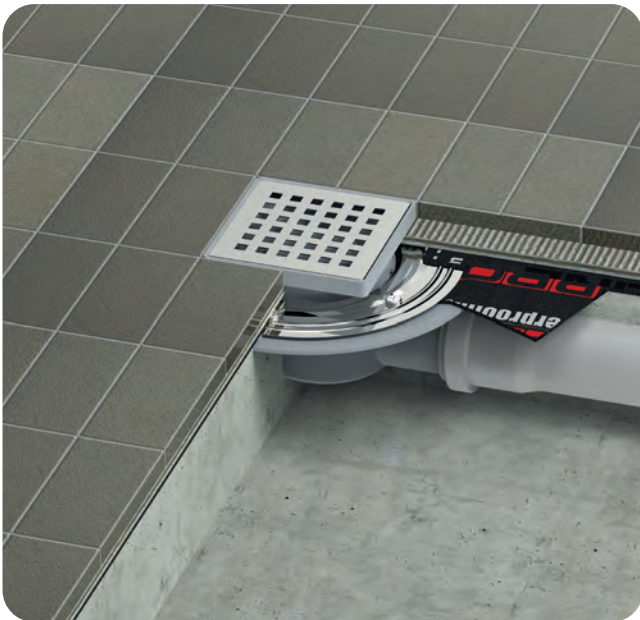

PARAPET

Ürün Kodu	Kısa Kod	Çap		Fiyat
YAN ÇIKIŞ				
8001.0Y070.00.0	14387	Ø 70	30	76.70
8002.0Y100.00.0	14389	Ø 100	25	96.70



DİK İNİŞ

Ürün Kodu	Kısa Kod	Çap		Fiyat
8001.0A070.00.0	14387	Ø 70	30	76.70
8002.0A100.00.0	14389	Ø 100	25	96.70



ÇATI HAVALANDIRMA

Ürün Kodu	Kısa Kod	Çap		Fiyat
ÇATI HAVALANDIRMA ŞAPKASI				
8003.0D070.00.0	14394	Ø 70	150	34.40
8004.0D100.00.0	14396	Ø 100	90	35.70
ÇATI HAVALANDIRMA SET				
8005.0D070.00.0	28907	Ø 70	150	103.40
8006.0D100.00.0	28908	Ø 100	90	126.70



PARAPET ARA BAĞLARI

Ürün Kodu	Kısa Kod	Çap		Fiyat
8201.0A070.10.0	14398	Ø 70	400	20.00
8202.0A100.10.0	14399	Ø 100	300	20.00



YAPRAK TUTUCU

Ürün Kodu	Kısa Kod	Çıkış		Fiyat
9302.0D070.00.0	31308	Ø 50-70	400	26.70
9302.0D100.00.0	14395	Ø 70-100	175	30.00

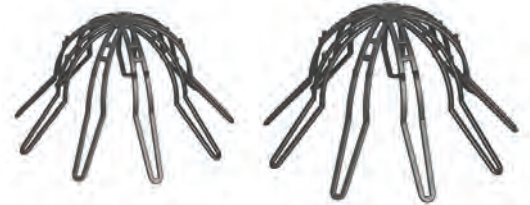

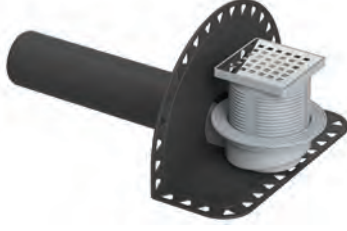

- 8001- Ø 70 Parapet + 5014.0Y050.10.1 Sifon Takımı
- 8002- Ø 100 Parapet + 5014.0Y070.10.1 Sifon Takımı

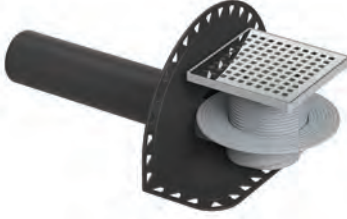

- 8001- Ø 70 Parapet + 5018.0Y050.15.1 Sifon Takımı
- 8002- Ø 100 Parapet + 5018.0Y070.15.1 Sifon Takımı

PARAPET İKİZ GİDER

Ürün Kodu	Kısa Kod	Çap	Ölçü	Fiyat
10x10				
8101.0Y070.10.1	14400	Ø 70	10x10 cm	270.00
8101.0Y100.10.1	14402	Ø 100	10x10 cm	290.00
15x15				
8101.0Y070.15.1	14403	Ø 70	15x15 cm	316.70
8101.0Y100.15.1	14405	Ø 100	15x15 cm	340.00



DİK İNİŞ İKİZ GİDER

Ürün Kodu	Kısa Kod	Çap	Ölçü	Fiyat
10x10				
8102.0A070.10.1	14401	Ø 70	10x10 cm	233.40
8102.0A100.10.1	14404	Ø 100	10x10 cm	246.70
15x15				
8102.0A070.15.1	14406	Ø 70	15x15 cm	276.70
8102.0A100.15.1	14407	Ø 100	15x15 cm	290.00

- 8001- Ø 70 Parapet + 8201 Ara Bağlantı + 5101 Sifon Üst Gövde
- 8002- Ø 100 Parapet + 8202 Ara Bağlantı + 5101 Sifon Üst Gövde



- 8001- Ø 70 Parapet + 8201 Ara Bağlantı + 5101 Sifon Üst Gövde
- 8002- Ø 100 Parapet + 8202 Ara Bağlantı + 5101 Sifon Üst Gövde

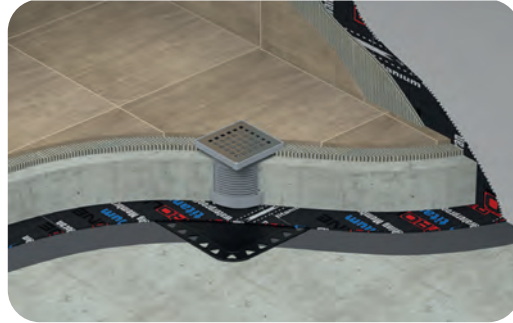

SHINGLE HAVALANDIRMA

Ürün Kodu	Kısa Kod	Ölçü	Fiyat
8010.YD080.00.S	14408	Siyah 34x44x8.5 cm	24 143.40
8010.YD080.00.Y	14411	Yeşil 34x44x8.5 cm	24 146.70
8010.YD080.00.K	14412	Kırmızı 34x44x8.5 cm	24 146.70



- Polypropylene

LINE

Ürün Kodu	Kısa Kod	Çıkış	Ölçü		Fiyat
ALÇAK SEVİYELİ					
4012.0Y050A.020.1	21668	Ø 50	20 cm	12	220.00
4012.0Y050A.033.1	21634	Ø 50	33 cm	12	296.70
4012.0Y050A.040.1	21645	Ø 50	40 cm	12	330.00
4012.0Y050A.050.1	21658	Ø 50	50 cm	12	390.00
4012.0Y050A.060.1	21684	Ø 50	60 cm	12	433.40
ALÇAK SEVİYELİ					
4012.0A050A.020.1	21536	Ø 50	20 cm	12	220.00
4012.0A050A.033.1	21552	Ø 50	33 cm	12	296.70
4012.0A050A.040.1	21565	Ø 50	40 cm	12	330.00
4012.0A050A.050.1	21575	Ø 50	50 cm	12	390.00
4012.0A050A.060.1	21585	Ø 50	60 cm	12	433.40

Duş kanalı / W200-330-400-500-600 mm / Ø 50 yan - alt çıkış
Plastik gövde / Paslanmaz ızgara / Sulu koku tutucu



LINE

Ürün Kodu	Kısa Kod	Çıkış	Ölçü		Fiyat
YAN ÇIKIŞ					
4012.0Y050K.020.1	14414	Ø 50	20 cm	12	220.00
4012.0Y050K.033.1	14431	Ø 50	33 cm	12	296.70
4012.0Y050K.040.1	14445	Ø 50	40 cm	12	330.00
4012.0Y050K.050.1	14465	Ø 50	50 cm	12	390.00
4012.0Y050K.060.1	14474	Ø 50	60 cm	12	433.40
4012.0Y050K.080.1	14491	Ø 50	80 cm	12	540.00
ALT ÇIKIŞ					
4012.0A050K.020.1	14415	Ø 50	20 cm	12	220.00
4012.0A050K.033.1	14430	Ø 50	33 cm	12	296.70
4012.0A050K.040.1	14448	Ø 50	40 cm	12	330.00
4012.0A050K.050.1	14463	Ø 50	50 cm	12	390.00
4012.0A050K.060.1	14488	Ø 50	60 cm	12	433.40
4012.0A050K.080.1	14503	Ø 50	80 cm	12	540.00

Duş kanalı / W200-330-400-500-600-800 mm / Ø 50 yan - alt çıkış
Plastik gövde / Paslanmaz ızgara / Sulu koku tutucu



Detaylar

DN 50 Yan ve Alt çıkış – Pvc boru bağlantılarına uyumlu. sulu tip (36mm) koku önleyiciye sahiptir. Akış hızı 32 lt/dk'dır. Dış kimyasal etkilere dayanım çalışma sıcaklığı -30°+75° arasındır. Izgarası 304 kalite paslanmaz çeliktir.

Avantajlar

304 kalite paslanmaz çelik ızgarası sayesinde şık ve kaliteli bir görünüme sahiptir. Duvar dibi uygulamalarda rahatlıkla uygulanabilir. Su tutuculu koku önleyici sayesinde tesisattan gelecek kötü kokuları önler. Yükseltme ayakları sayesinde şapın yüksekliğine göre ayarlama olanağı sağlar. Organik ve inorganik kimyasallara yüksek dayanım. çoğu asidik ve tuzlu su oksidasyonuna dayanıklıdır.

Kullanım Alanları

Genel kullanım banyo duşları, hastane ve otel duş alanları, soyunma odaları duş alanları vb.

Özel Üretim

Izgara modeli olarak isteğinize göre altın, bronz gibi renkler de üretilmektedir.

Uyarı

Yüksek yoğunluklu temizlik malzemelerinin uzun süreli kullanımı tavsiye edilmez.

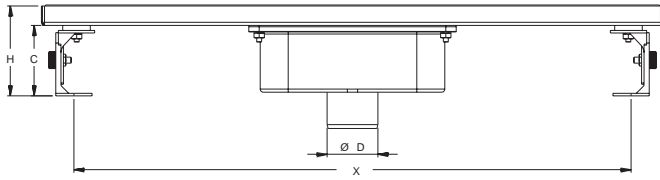
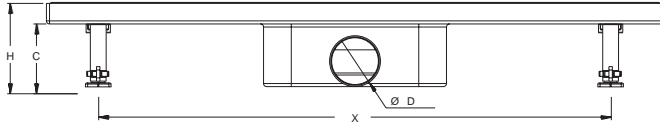
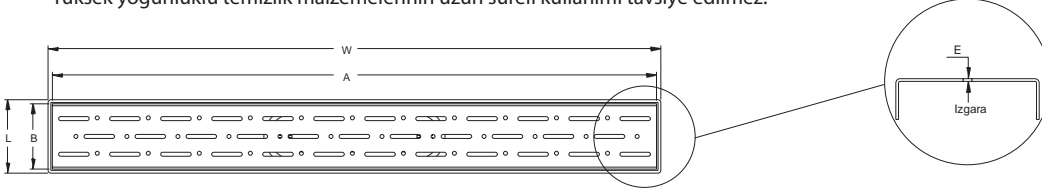

	W	L	H	Ø D	A	B	C	X	E
4012.0Y050K.020.1	205	72	88	49.5	196	64	68	-	1
4012.0Y050K.033.1	330	72	88	49.5	322	64	68	285	1
4012.0Y050K.040.1	400	72	88	49.5	392	64	68	335	1
4012.0Y050K.050.1	500	72	88	49.5	492	64	68	435	1
4012.0Y050K.060.1	600	72	88	49.5	592	64	68	556	1
4012.0Y050K.080.1	785	72	88	49.5	778	64	68	737	1

	W	L	H	Ø D	A	B	C	X	E
4012.0A050K.020.1	205	72	115	49.5	196	64	68	-	1
4012.0A050K.033.1	330	72	115	49.5	322	64	68	285	1
4012.0A050K.040.1	400	72	115	49.5	392	64	68	335	1
4012.0A050K.050.1	500	72	115	49.5	492	64	68	435	1
4012.0A050K.060.1	600	72	115	49.5	592	64	68	556	1
4012.0A050K.080.1	785	72	115	49.5	778	64	68	737	1



LEGAL

Ürün Kodu	Kısa Kod	Çıkış	Ölçü		Fiyat
YAN ÇIKIŞ					
4013.0Y050K.020.1	14602	Ø 50	20 cm	12	360.00
4013.0Y050K.033.1	14613	Ø 50	33 cm	12	540.00
4013.0Y050K.040.1	14626	Ø 50	40 cm	12	603.40
4013.0Y050K.050.1	14636	Ø 50	50 cm	12	716.70
4013.0Y050K.060.1	14649	Ø 50	60 cm	12	820.00
4013.0Y050K.080.1	14668	Ø 50	80 cm	12	1006.70
ALT ÇIKIŞ					
4013.0A050K.020.1	14651	Ø 50	20 cm	12	360.00
4013.0A050K.033.1	14667	Ø 50	33 cm	12	540.00
4013.0A050K.040.1	14685	Ø 50	40 cm	12	603.40
4013.0A050K.050.1	14701	Ø 50	50 cm	12	716.70
4013.0A050K.060.1	14722	Ø 50	60 cm	12	820.00
4013.0A050K.080.1	14734	Ø 50	80 cm	12	1006.70

Duş kanalı / W200-330-400-500-600-800 mm / Ø 50 yan - alt çıkış
Paslanmaz gövde / Paslanmaz ızgara / Sulu koku tutucu

LEGAL Y360°

Ürün Kodu	Kısa Kod	Çıkış	Ölçü		Fiyat
YAN ÇIKIŞ					
4013.0Y360K.020.1	14879	Ø 50	20 cm	12	450.00
4013.0Y360K.033.1	14902	Ø 50	33 cm	12	643.40
4013.0Y360K.040.1	14916	Ø 50	40 cm	12	710.00
4013.0Y360K.050.1	14928	Ø 50	50 cm	12	830.00
4013.0Y360K.060.1	14937	Ø 50	60 cm	12	933.40
4013.0Y360K.080.1	14946	Ø 50	80 cm	12	1130.00
ALT ÇIKIŞ					
4013.0A360K.020.1	14971	Ø 50	20 cm	12	450.00
4013.0A360K.033.1	14994	Ø 50	33 cm	12	643.40
4013.0A360K.040.1	15007	Ø 50	40 cm	12	710.00
4013.0A360K.050.1	15027	Ø 50	50 cm	12	830.00
4013.0A360K.060.1	15038	Ø 50	60 cm	12	933.40
4013.0A360K.080.1	15050	Ø 50	80 cm	12	1130.00

Duş kanalı / W200-330-400-500-600-800 mm / Ø 50 yan - alt çıkış
Paslanmaz gövde / Paslanmaz ızgara / Sulu koku tutucu



HM-31363

Legal koku tutucu kullanılmaktadır.



HM-31363

Legal koku tutucu kullanılmaktadır.



KLASİK SIMPLE LEGAL



HM-31359

Style koku tutucu kullanılmaktadır.

Ürün Kodu	Kısa Kod	Çıkış	Ölçü	Fiyat
4013.0Y050P020.1	23264	Ø 50	20 cm	346.70
4013.0Y050P033.1	23289	Ø 50	33 cm	463.40
4013.0Y050P040.1	23297	Ø 50	40 cm	530.00
4013.0Y050P050.1	23312	Ø 50	50 cm	650.00
4013.0Y050P060.1	23320	Ø 50	60 cm	750.00
4013.0Y050P080.1	23337	Ø 50	80 cm	930.00

Duş kanalı / W200-330-400-500-600-800 mm / Ø 50 yan - alt çıkış
Paslanmaz gövde / Paslanmaz ızgara / Sulu koku tutucu

LEGAL



HM-31359

Style koku tutucu kullanılmaktadır.

Ürün Kodu	Kısa Kod	Çıkış	Ölçü	Fiyat
YAN ÇIKIŞ				
4015.0Y050P020.1	31213	Ø 50	20 cm	423.40
4015.0Y050P033.1	31217	Ø 50	33 cm	576.70
4015.0Y050P040.1	31221	Ø 50	40 cm	643.40
4015.0Y050P050.1	31225	Ø 50	50 cm	763.40
4015.0Y050P060.1	31229	Ø 50	60 cm	870.00
4015.0Y050P080.1	31233	Ø 50	80 cm	1046.70

ALT ÇIKIŞ

4015.0A050P020.1	31237	Ø 50	20 cm	423.40
4015.0A050P033.1	31241	Ø 50	33 cm	576.70
4015.0A050P040.1	31245	Ø 50	40 cm	643.40
4015.0A050P050.1	31248	Ø 50	50 cm	763.40
4015.0A050P060.1	31253	Ø 50	60 cm	870.00
4015.0A050P080.1	31257	Ø 50	80 cm	1046.70

Duş kanalı / W200-330-400-500-600-800 mm / Ø 50 yan - alt çıkış
Paslanmaz gövde / Paslanmaz ızgara / Sulu koku tutucu

LEGAL Y360°



HM-31359

Style koku tutucu kullanılmaktadır.

Ürün Kodu	Kısa Kod	Çıkış	Ölçü	Fiyat
YAN ÇIKIŞ				
4018.0Y050P020.1	31273	Ø 50	20 cm	503.40
4018.0Y050P033.1	31277	Ø 50	33 cm	670.00
4018.0Y050P040.1	31281	Ø 50	40 cm	736.70
4018.0Y050P050.1	31285	Ø 50	50 cm	853.40
4018.0Y050P060.1	31289	Ø 50	60 cm	960.00
4018.0Y050P080.1	31293	Ø 50	80 cm	1156.70

ALT ÇIKIŞ

4018.0A050P020.1	31487	Ø 50	20 cm	503.40
4018.0A050P033.1	31491	Ø 50	33 cm	670.00
4018.0A050P040.1	31495	Ø 50	40 cm	736.70
4018.0A050P050.1	31499	Ø 50	50 cm	853.40
4018.0A050P060.1	31503	Ø 50	60 cm	960.00
4018.0A050P080.1	31507	Ø 50	80 cm	1156.70

Duş kanalı / W200-330-400-500-600-800 mm / Ø 50 yan - alt çıkış
Paslanmaz gövde / Paslanmaz ızgara / Sulu koku tutucu

SCALA

Ürün Kodu	Kısa Kod	Çıkış	Ölçü		Fiyat
YAN ÇIKIŞ					
4014.0Y050K.020.1	15086	Ø 50	20 cm	12	366.70
4014.0Y050K.033.1	15087	Ø 50	33 cm	12	550.00
4014.0Y050K.040.1	15088	Ø 50	40 cm	12	610.00
4014.0Y050K.050.1	15090	Ø 50	50 cm	12	730.00
4014.0Y050K.060.1	15092	Ø 50	60 cm	12	830.00
4014.0Y050K.080.1	15095	Ø 50	80 cm	12	1006.70
ALT ÇIKIŞ					
4014.0A050K.020.1	15072	Ø 50	20 cm	12	366.70
4014.0A050K.033.1	15076	Ø 50	33 cm	12	550.00
4014.0A050K.040.1	15078	Ø 50	40 cm	12	610.00
4014.0A050K.050.1	15080	Ø 50	50 cm	12	730.00
4014.0A050K.060.1	15082	Ø 50	60 cm	12	830.00
4014.0A050K.080.1	15084	Ø 50	80 cm	12	1006.70

Duş kanalı / W200-330-400-500-600-800 mm / Ø 50 yan - alt çıkış
Paslanmaz gövde / Paslanmaz seramik uyumlu çerçeve / Sulu koku tutucu



HM-31363

Legal koku tutucu kullanılmaktadır.

SCALA Y360°

Ürün Kodu	Kısa Kod	Çıkış	Ölçü		Fiyat
YAN ÇIKIŞ					
4014.0Y360K.020.1	15110	Ø 50	20 cm	12	456.70
4014.0Y360K.033.1	15112	Ø 50	33 cm	12	646.70
4014.0Y360K.040.1	15114	Ø 50	40 cm	12	706.70
4014.0Y360K.050.1	15116	Ø 50	50 cm	12	830.00
4014.0Y360K.060.1	15117	Ø 50	60 cm	12	933.40
4014.0Y360K.080.1	15118	Ø 50	80 cm	12	1116.70
ALT ÇIKIŞ					
4014.0A360K.020.1	31365	Ø 50	20 cm	12	456.70
4014.0A360K.033.1	31366	Ø 50	33 cm	12	646.70
4014.0A360K.040.1	31367	Ø 50	40 cm	12	706.70
4014.0A360K.050.1	31368	Ø 50	50 cm	12	830.00
4014.0A360K.060.1	31369	Ø 50	60 cm	12	933.40
4014.0A360K.080.1	31370	Ø 50	80 cm	12	1116.70

Duş kanalı / W200-330-400-500-600-800 mm / Ø 50 yan - alt çıkış
Paslanmaz gövde / Paslanmaz seramik uyumlu çerçeve / Sulu koku tutucu



HM-31363

Legal koku tutucu kullanılmaktadır.

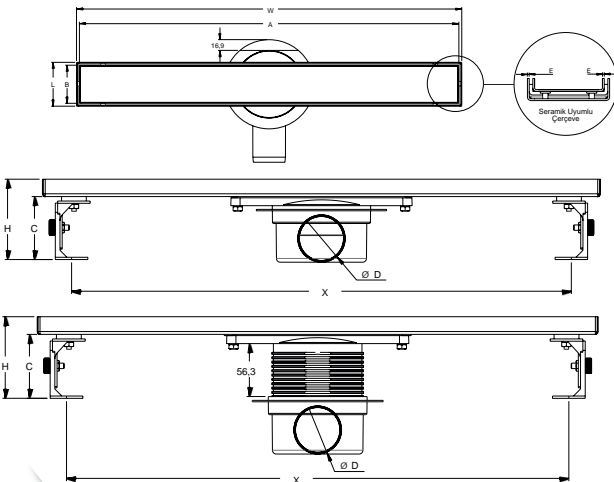

ÜRÜN KODU

ÜRÜN KODU	W	L	H	Ø D	A	B	C	X	E
4014.00360K.033.1	330	72	88	49.5	316	58	68	285	1
4014.00360K.040.1	400	72	88	49.5	388	58	68	335	1
4014.00360K.050.1	500	72	88	49.5	487	58	68	435	1
4014.00360K.060.1	600	72	88	49.5	589	58	68	556	1
4014.00360K.080.1	785	72	88	49.5	773	58	68	737	1

ÜRÜN KODU

ÜRÜN KODU	W	L	H	Ø D	A	B	C	X	E
4014.0Y360K.033.1	330	72	154	49.5	316	58	68	285	1
4014.0Y360K.040.1	400	72	154	49.5	388	58	68	335	1
4014.0Y360K.050.1	500	72	154	49.5	487	58	68	435	1
4014.0Y360K.060.1	600	72	154	49.5	589	58	68	556	1
4014.0Y360K.080.1	785	72	154	49.5	773	58	68	737	1

Tablo ölçü birimi "mm"dir.

STYLE SERİSİ

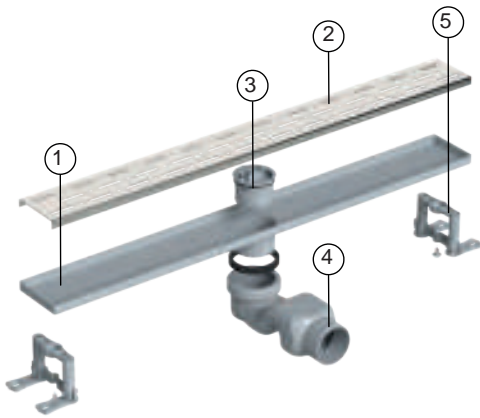

PARÇA NO	PARÇA AÇIKLAMASI	MALZEME	ADET
4083.1	Paslanmaz Üst Gövde	AISI 304	1
4083.2	Paslanmaz Izgara	AISI 304	1
4083.3	Koku Tutucu	PP	1
4083.4	S Sifon	PP	1
4083.5	Yükseklik Ayarlı Montaj Seti	PP	2

Detaylar

DN 50 Yan ve Alt çıkış – Pvc boru bağlantılarına uyumludur. Akış hızı 32 lt/dk'dır. Izgarası 304 kalite paslanmaz çeliktir.

Avantajlar

304 kalite paslanmaz çelik ızgarası sayesinde şık ve kaliteli bir görünüme sahiptir. Duvar dibi uygulamalarda rahatlıkla kullanılabilir. Su tutuculu koku önleyici sayesinde tesisattan gelecek kötü kokuları önler. Yükseltme ayakları sayesinde şapın yüksekliğine göre ayarlama olanağı sağlar. Organik ve inorganik kimyasallara yüksek dayanım. çoğu asidik ve tuzlu su oksidasyonuna dayanıklıdır.

Kullanım Alanları

Genel kullanım banyo duşları, hastane ve otel duş alanları, soyunma odaları duş alanları vb.

Özel Üretim

Izgara modeli olarak isteğinize göre altın, bronz gibi renkler de üretilmektedir.

Uyarı

Yüksek yoğunluklu temizlik malzemelerinin uzun süreli kullanımı tavsiye edilmez.

SIMPLE LINE

Ürün Kodu	Kısa Kod	Çıkış	Ölçü		Fiyat
ALT ÇIKIŞ					
4080.0A050K.033.1	15119	Ø 50	33 cm	12	206.70
4080.0A050K.040.1	15148	Ø 50	40 cm	12	253.40
4080.0A050K.050.1	15162	Ø 50	50 cm	12	306.70
4080.0A050K.060.1	15199	Ø 50	60 cm	12	346.70
4080.0A050K.080.1	15216	Ø 50	80 cm	12	410.00

Duş kanalı / W330-400-500-600-800 mm / Ø 50 yan - alt çıkış
Plastik gövde / Paslanmaz ızgara / Sulu koku tutucu



HM-31359

Style koku tutucu kullanılmaktadır.

LINE

Ürün Kodu	Kısa Kod	Çıkış	Ölçü		Fiyat
YAN ÇIKIŞ					
4081.0Y050K.033.1	15160	Ø 50	33 cm	12	280.00
4081.0Y050K.040.1	15172	Ø 50	40 cm	12	323.40
4081.0Y050K.050.1	15187	Ø 50	50 cm	12	380.00
4081.0Y050K.060.1	15197	Ø 50	60 cm	12	420.00
4081.0Y050K.080.1	15213	Ø 50	80 cm	12	483.40
ALT ÇIKIŞ					
4082.0A050K.033.1	15228	Ø 50	33 cm	12	280.00
4082.0A050K.040.1	15239	Ø 50	40 cm	12	323.40
4082.0A050K.050.1	15254	Ø 50	50 cm	12	380.00
4082.0A050K.060.1	15269	Ø 50	60 cm	12	420.00
4082.0A050K.080.1	15295	Ø 50	80 cm	12	483.40

Duş kanalı / W330-400-500-600-800 mm / Ø 50 yan - alt çıkış
Plastik gövde / Paslanmaz ızgara / Sulu koku tutucu

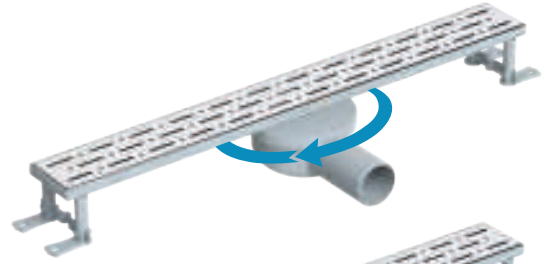

HM-31359

Style koku tutucu kullanılmaktadır.

LINE FİLELİ

Ürün Kodu	Kısa Kod	Çıkış	Ölçü		Fiyat
YAN ÇIKIŞ					
4092.FY050K.033.1	15585	Ø 50	33 cm	12	306.70
4092.FY050K.040.1	15603	Ø 50	40 cm	12	350.00
4092.FY050K.050.1	15623	Ø 50	50 cm	12	403.40
4092.FY050K.060.1	15637	Ø 50	60 cm	12	443.40
4092.FY050K.080.1	15647	Ø 50	80 cm	12	520.00
ALT ÇIKIŞ					
4093.FA050K.033.1	15591	Ø 50	33 cm	12	306.70
4093.FA050K.040.1	15613	Ø 50	40 cm	12	350.00
4093.FA050K.050.1	15635	Ø 50	50 cm	12	403.40
4093.FA050K.060.1	15662	Ø 50	60 cm	12	443.40
4093.FA050K.080.1	15698	Ø 50	80 cm	12	520.00

Duş kanalı / W330-400-500-600-800 mm / Ø 50 yan - alt çıkış
Plastik gövde / Paslanmaz ızgara / Sulu koku tutucu

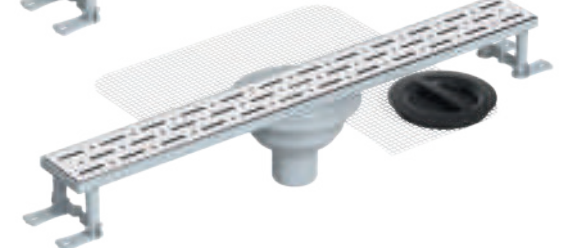
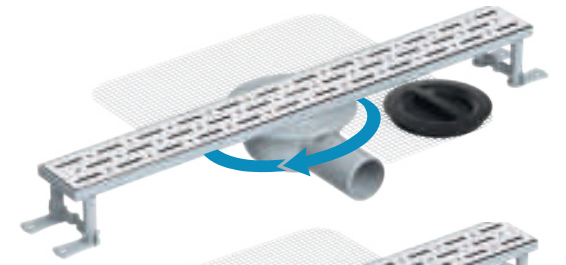

HM-31359

Style koku tutucu kullanılmaktadır.



RAIN



KARE



BAHN



HM-31359

Style koku tutucu kullanılmaktadır.

STYLE SİFONİK

Ürün Kodu	Kısa Kod	Çıkış	Ölçü		Fiyat
YAN ÇIKIŞ					
4083.0Y050K.033.1	15243	Ø 50	33 cm	12	270.00
4083.0Y050K.040.1	15270	Ø 50	40 cm	12	313.40
4083.0Y050K.050.1	15282	Ø 50	50 cm	12	370.00
4083.0Y050K.060.1	15300	Ø 50	60 cm	12	410.00
4083.0Y050K.080.1	15312	Ø 50	80 cm	12	473.40

Duş kanalı / W330-400-500-600-800 mm / Ø 50 yan - alt çıkış
Plastik gövde / Paslanmaz ızgara / Sulu koku tutucu

LINE Y360°

Ürün Kodu	Kısa Kod	Çıkış	Ölçü		Fiyat
YAN ÇIKIŞ					
4085.0Y050K.033.1	29857	Ø 50	33 cm	12	343.40
4085.0Y050K.040.1	29860	Ø 50	40 cm	12	396.70
4085.0Y050K.050.1	29863	Ø 50	50 cm	12	453.40
4085.0Y050K.060.1	29866	Ø 50	60 cm	12	493.40
4085.0Y050K.080.1	29869	Ø 50	80 cm	12	580.00

ALT ÇIKIŞ

4085.0A050K.033.1	29872	Ø 50	33 cm	12	343.40
4085.0A050K.040.1	29875	Ø 50	40 cm	12	396.70
4085.0A050K.050.1	29878	Ø 50	50 cm	12	453.40
4085.0A050K.060.1	29881	Ø 50	60 cm	12	493.40
4085.0A050K.080.1	29884	Ø 50	80 cm	12	580.00

Duş kanalı / W330-400-500-600-800 mm / Ø 50 yan - alt çıkış
Plastik gövde / Paslanmaz ızgara / Sulu koku tutucu



HM-31359

Style koku tutucu kullanılmaktadır.

LINE FİLELİ Y360°

Ürün Kodu	Kısa Kod	Çıkış	Ölçü		Fiyat
YAN ÇIKIŞ					
4090.FY050K.033.1	29935	Ø 50	33 cm	12	353.40
4090.FY050K.040.1	29939	Ø 50	40 cm	12	396.70
4090.FY050K.050.1	29943	Ø 50	50 cm	12	450.00
4090.FY050K.060.1	29947	Ø 50	60 cm	12	490.00
4090.FY050K.080.1	29951	Ø 50	80 cm	12	570.00

ALT ÇIKIŞ

4090.FA050K.033.1	29955	Ø 50	33 cm	12	353.40
4090.FA050K.040.1	29959	Ø 50	40 cm	12	396.70
4090.FA050K.050.1	29963	Ø 50	50 cm	12	450.00
4090.FA050K.060.1	29967	Ø 50	60 cm	12	490.00
4090.FA050K.080.1	29971	Ø 50	80 cm	12	570.00

Duş kanalı / W330-400-500-600-800 mm / Ø 50 yan - alt çıkış
Plastik gövde / Paslanmaz ızgara / Sulu koku tutucu

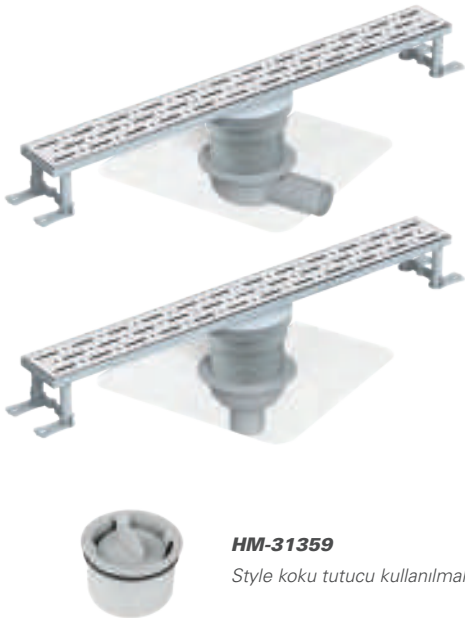

HM-31359

Style koku tutucu kullanılmaktadır.



RAIN

KARE

BAHN

SIMPLE LEGAL

Ürün Kodu	Kısa Kod	Çıkış	Ölçü		Fiyat
ALT ÇIKIŞ					
4086.0A050K.020.1	15329	Ø 50	20 cm	12	273.40
4086.0A050K.033.1	15338	Ø 50	33 cm	12	363.40
4086.0A050K.040.1	15347	Ø 50	40 cm	12	416.70
4086.0A050K.050.1	15363	Ø 50	50 cm	12	510.00
4086.0A050K.060.1	15381	Ø 50	60 cm	12	583.40
4086.0A050K.080.1	15420	Ø 50	80 cm	12	716.70

Duş kanalı / W200-330-400-500-600-800 mm / Ø 50 yan - alt çıkış
Paslanmaz gövde / Paslanmaz ızgara / Sulu koku tutucu



HM-31359

Style koku tutucu kullanılmaktadır.

LEGAL

Ürün Kodu	Kısa Kod	Çıkış	Ölçü		Fiyat
YAN ÇIKIŞ					
4087.0Y050K.020.1	15445	Ø 50	20 cm	12	333.40
4087.0Y050K.033.1	15471	Ø 50	33 cm	12	423.40
4087.0Y050K.040.1	15490	Ø 50	40 cm	12	476.70
4087.0Y050K.050.1	15508	Ø 50	50 cm	12	570.00
4087.0Y050K.060.1	15532	Ø 50	60 cm	12	646.70
4087.0Y050K.080.1	15580	Ø 50	80 cm	12	780.00
ALT ÇIKIŞ					
4088.0A050K.020.1	15321	Ø 50	20 cm	12	333.40
4088.0A050K.033.1	15366	Ø 50	33 cm	12	423.40
4088.0A050K.040.1	15383	Ø 50	40 cm	12	476.70
4088.0A050K.050.1	15396	Ø 50	50 cm	12	570.00
4088.0A050K.060.1	15417	Ø 50	60 cm	12	646.70
4088.0A050K.080.1	15446	Ø 50	80 cm	12	780.00

Duş kanalı / W200-330-400-500-600-800 mm / Ø 50 yan - alt çıkış
Paslanmaz gövde / Paslanmaz ızgara / Sulu koku tutucu

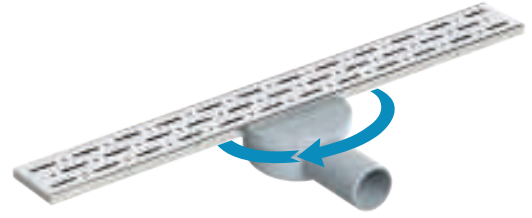

HM-31359

Style koku tutucu kullanılmaktadır.

LEGAL FİLELİ

Ürün Kodu	Kısa Kod	Çıkış	Ölçü		Fiyat
YAN ÇIKIŞ					
4094.FY050K.020.1	15665	Ø 50	20 cm	12	390.00
4094.FY050K.033.1	15680	Ø 50	33 cm	12	486.70
4094.FY050K.040.1	15692	Ø 50	40 cm	12	543.40
4094.FY050K.050.1	15706	Ø 50	50 cm	12	643.40
4094.FY050K.060.1	15731	Ø 50	60 cm	12	723.40
4094.FY050K.080.1	15784	Ø 50	80 cm	12	883.40
ALT ÇIKIŞ					
4094.FA050K.020.1	15714	Ø 50	20 cm	12	390.00
4094.FA050K.033.1	15728	Ø 50	33 cm	12	486.70
4094.FA050K.040.1	15740	Ø 50	40 cm	12	543.40
4094.FA050K.050.1	15754	Ø 50	50 cm	12	643.40
4094.FA050K.060.1	15767	Ø 50	60 cm	12	723.40
4094.FA050K.080.1	15793	Ø 50	80 cm	12	883.40

Duş kanalı / W200-330-400-500-600-800 mm / Ø 50 yan - alt çıkış
Paslanmaz gövde / Paslanmaz ızgara / Sulu koku tutucu

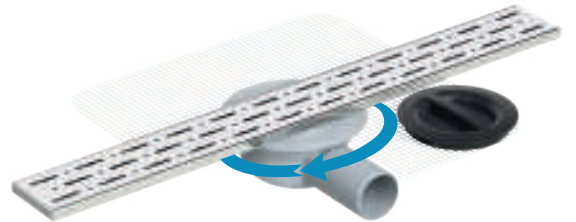

HM-31359

Style koku tutucu kullanılmaktadır.



RAIN

KARE

BAHN

LEGAL SİFONİK



HM-31359

Style koku tutucu kullanılmaktadır.

Ürün Kodu	Kısa Kod	Çıkış	Ölçü		Fiyat
YAN ÇIKIŞ					
4084.0Y050K.020.1	15457	Ø 50	20 cm	12	306.70
4084.0Y050K.033.1	15479	Ø 50	33 cm	12	393.40
4084.0Y050K.040.1	15495	Ø 50	40 cm	12	443.40
4084.0Y050K.050.1	15517	Ø 50	50 cm	12	533.40
4084.0Y050K.060.1	15536	Ø 50	60 cm	12	606.70
4084.0Y050K.080.1	15565	Ø 50	80 cm	12	733.40

Duş kanalı / W200-330-400-500-600-800 mm / Ø 50 yan - alt çıkış
Paslanmaz gövde / Paslanmaz ızgara / Sulu koku tutucu

LEGAL Y360°



HM-31359

Style koku tutucu kullanılmaktadır.

Ürün Kodu	Kısa Kod	Çıkış	Ölçü		Fiyat
YAN ÇIKIŞ					
4089.0Y050K.020.1	29887	Ø 50	20 cm	12	396.70
4089.0Y050K.033.1	29891	Ø 50	33 cm	12	486.70
4089.0Y050K.040.1	29895	Ø 50	40 cm	12	543.40
4089.0Y050K.050.1	29899	Ø 50	50 cm	12	633.40
4089.0Y050K.060.1	29903	Ø 50	60 cm	12	706.70
4089.0Y050K.080.1	29907	Ø 50	80 cm	12	856.70

ALT ÇIKIŞ

4089.0A050K.020.1	29911	Ø 50	20 cm	12	396.70
4089.0A050K.033.1	29915	Ø 50	33 cm	12	486.70
4089.0A050K.040.1	29919	Ø 50	40 cm	12	543.40
4089.0A050K.050.1	29923	Ø 50	50 cm	12	633.40
4089.0A050K.060.1	29927	Ø 50	60 cm	12	706.70
4089.0A050K.080.1	29931	Ø 50	80 cm	12	856.70

Duş kanalı / W200-330-400-500-600-800 mm / Ø 50 yan - alt çıkış
Paslanmaz gövde / Paslanmaz ızgara / Sulu koku tutucu

LEGAL FİLELİ Y360°

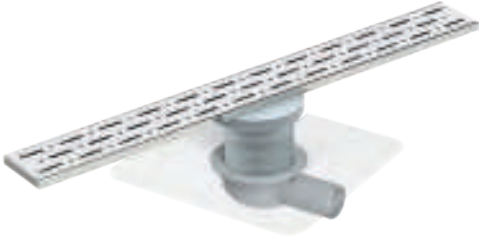

HM-31359

Style koku tutucu kullanılmaktadır.

Ürün Kodu	Kısa Kod	Çıkış	Ölçü		Fiyat
YAN ÇIKIŞ					
4095.FY050K.020.1	30753	Ø 50	20 cm	12	426.70
4095.FY050K.033.1	29975	Ø 50	33 cm	12	520.00
4095.FY050K.040.1	29979	Ø 50	40 cm	12	576.70
4095.FY050K.050.1	29983	Ø 50	50 cm	12	670.00
4095.FY050K.060.1	29987	Ø 50	60 cm	12	746.70
4095.FY050K.080.1	29991	Ø 50	80 cm	12	903.40

ALT ÇIKIŞ

4095.FA050K.020.1	30757	Ø 50	20 cm	12	426.70
4095.FA050K.033.1	29995	Ø 50	33 cm	12	520.00
4095.FA050K.040.1	29999	Ø 50	40 cm	12	576.70
4095.FA050K.050.1	30003	Ø 50	50 cm	12	670.00
4095.FA050K.060.1	30007	Ø 50	60 cm	12	746.70
4095.FA050K.080.1	30011	Ø 50	80 cm	12	903.40

Duş kanalı / W200-330-400-500-600-800 mm / Ø 50 yan - alt çıkış
Paslanmaz gövde / Paslanmaz ızgara / Sulu koku tutucu



RAIN

KARE

BAHN

SİMPLE VEGA

Ürün Kodu	Kısa Kod	Çıkış	Ölçü		Fiyat
ALT ÇIKIŞ					
4074.0A050K.040.1	15802	Ø 50	40 cm	12	396.70
4074.0A050K.050.1	15812	Ø 50	50 cm	12	456.70
4074.0A050K.060.1	15821	Ø 50	60 cm	12	516.70

Duş kanalı / W200-330-400-500-600-800 mm / Ø 50 yan - alt çıkış
Paslanmaz gövde / Paslanmaz ızgara / Sulu koku tutucu



HM-31359

Style koku tutucu kullanılmaktadır.

VEGA

Ürün Kodu	Kısa Kod	Çıkış	Ölçü		Fiyat
YAN ÇIKIŞ					
4075.0Y050K.040.1	15830	Ø 50	40 cm	12	476.70
4075.0Y050K.050.1	15843	Ø 50	50 cm	12	536.70
4075.0Y050K.060.1	15858	Ø 50	60 cm	12	606.70
ALT ÇIKIŞ					
4075.0A050K.040.1	15835	Ø 50	40 cm	12	476.70
4075.0A050K.050.1	15856	Ø 50	50 cm	12	536.70
4075.0A050K.060.1	15871	Ø 50	60 cm	12	606.70

Duş kanalı / W200-330-400-500-600-800 mm / Ø 50 yan - alt çıkış
Paslanmaz gövde / Paslanmaz ızgara / Sulu koku tutucu



HM-31359

Style koku tutucu kullanılmaktadır.

VEGA FİLELİ

Ürün Kodu	Kısa Kod	Çıkış	Ölçü		Fiyat
YAN ÇIKIŞ					
4075.FY050K.040.1	16002	Ø 50	40 cm	12	493.40
4075.FY050K.050.1	16011	Ø 50	50 cm	12	573.40
4075.FY050K.060.1	16020	Ø 50	60 cm	12	636.70
ALT ÇIKIŞ					
4075.FA050K.040.1	16031	Ø 50	40 cm	12	493.40
4075.FA050K.050.1	16051	Ø 50	50 cm	12	573.40
4075.FA050K.060.1	16066	Ø 50	60 cm	12	636.70

Duş kanalı / W200-330-400-500-600-800 mm / Ø 50 yan - alt çıkış
Paslanmaz gövde / Paslanmaz ızgara / Sulu koku tutucu

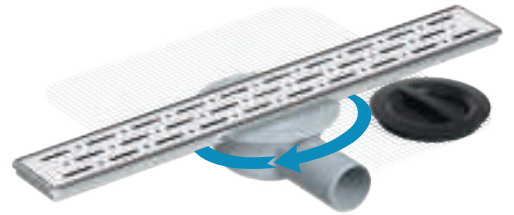

HM-31359

Style koku tutucu kullanılmaktadır.



RAIN

KARE

BAHN



HM-31359

Style koku tutucu kullanılmaktadır.

VEGA SIFONİK

Ürün Kodu	Kısa Kod	Çıkış	Ölçü	Fiyat
YAN ÇIKIŞ				
4076.0Y050K.040.1	15882	Ø 50	40 cm	446.70
4076.0Y050K.050.1	15911	Ø 50	50 cm	506.70
4076.0Y050K.060.1	15925	Ø 50	60 cm	573.40

Duş kanalı / W200-330-400-500-600-800 mm / Ø 50 yan - alt çıkış
Paslanmaz gövde / Paslanmaz ızgara / Sulu koku tutucu

VEGA Y360°



HM-31359

Style koku tutucu kullanılmaktadır.

Ürün Kodu	Kısa Kod	Çıkış	Ölçü	Fiyat
YAN ÇIKIŞ				
4070.0Y050K.040.1	30025	Ø 50	40 cm	523.40
4070.0Y050K.050.1	30029	Ø 50	50 cm	580.00
4070.0Y050K.060.1	30033	Ø 50	60 cm	643.40
ALT ÇIKIŞ				
4070.0A050K.040.1	30037	Ø 50	40 cm	523.40
4070.0A050K.050.1	30041	Ø 50	50 cm	580.00
4070.0A050K.060.1	30045	Ø 50	60 cm	643.40

Duş kanalı / W200-330-400-500-600-800 mm / Ø 50 yan - alt çıkış
Paslanmaz gövde / Paslanmaz ızgara / Sulu koku tutucu

VEGA FİLELİ Y360°



HM-31359

Style koku tutucu kullanılmaktadır.

Ürün Kodu	Kısa Kod	Çıkış	Ölçü	Fiyat
YAN ÇIKIŞ				
4069.FY050K.040.1	30073	Ø 50	40 cm	536.70
4069.FY050K.050.1	30077	Ø 50	50 cm	616.70
4069.FY050K.060.1	30081	Ø 50	60 cm	680.00
ALT ÇIKIŞ				
4069.FA050K.040.1	30085	Ø 50	40 cm	536.70
4069.FA050K.050.1	30089	Ø 50	50 cm	616.70
4069.FA050K.060.1	30093	Ø 50	60 cm	680.00

Duş kanalı / W200-330-400-500-600-800 mm / Ø 50 yan - alt çıkış
Paslanmaz gövde / Paslanmaz ızgara / Sulu koku tutucu



RAIN

KARE

BAHN

SİMPLE VEGA LUX

Ürün Kodu	Kısa Kod	Çıkış	Ölçü		Fiyat
ALT ÇIKIŞ					
4077.0A050K.040.1	15886	Ø 50	40 cm	12	473.40
4077.0A050K.050.1	15901	Ø 50	50 cm	12	550.00
4077.0A050K.060.1	15917	Ø 50	60 cm	12	610.00

Duş kanalı / W200-330-400-500-600-800 mm / Ø 50 yan - alt çıkış
Paslanmaz gövde / Paslanmaz çerçeve ve ızgara / Sulu koku tutucu



HM-31359

Style koku tutucu kullanılmaktadır.

VEGA LUX

Ürün Kodu	Kısa Kod	Çıkış	Ölçü		Fiyat
YAN ÇIKIŞ					
4078.0Y050K.040.1	15935	Ø 50	40 cm	12	516.70
4078.0Y050K.050.1	15952	Ø 50	50 cm	12	590.00
4078.0Y050K.060.1	15961	Ø 50	60 cm	12	670.00
ALT ÇIKIŞ					
4078.0A050K.040.1	15943	Ø 50	40 cm	12	516.70
4078.0A050K.050.1	16046	Ø 50	50 cm	12	590.00
4078.0A050K.060.1	16071	Ø 50	60 cm	12	670.00

Duş kanalı / W200-330-400-500-600-800 mm / Ø 50 yan - alt çıkış
Paslanmaz gövde / Paslanmaz çerçeve ve ızgara / Sulu koku tutucu



HM-31359

Style koku tutucu kullanılmaktadır.

VEGA LUX FİLELİ

Ürün Kodu	Kısa Kod	Çıkış	Ölçü		Fiyat
YAN ÇIKIŞ					
4078.FY050K.040.1	16083	Ø 50	40 cm	12	570.00
4078.FY050K.050.1	16094	Ø 50	50 cm	12	646.70
4078.FY050K.060.1	16117	Ø 50	60 cm	12	706.70
ALT ÇIKIŞ					
4078.FA050K.040.1	16086	Ø 50	40 cm	12	570.00
4078.FA050K.050.1	16109	Ø 50	50 cm	12	646.70
4078.FA050K.060.1	16143	Ø 50	60 cm	12	706.70

Duş kanalı / W200-330-400-500-600-800 mm / Ø 50 yan - alt çıkış
Paslanmaz gövde / Paslanmaz çerçeve ve ızgara / Sulu koku tutucu



HM-31359

Style koku tutucu kullanılmaktadır.



RAIN

KARE

BAHN



HM-31359

Style koku tutucu kullanılmaktadır.

VEGA LUX SIFONİK

Ürün Kodu	Kısa Kod	Çıkış	Ölçü	Fiyat
YAN ÇIKIŞ				
4079.0Y050K.040.1	15971	Ø 50	40 cm	526.70
4079.0Y050K.050.1	15981	Ø 50	50 cm	606.70
4079.0Y050K.060.1	15991	Ø 50	60 cm	666.70

Duş kanalı / W200-330-400-500-600-800 mm / Ø 50 yan - alt çıkış
Paslanmaz gövde / Paslanmaz çerçeve ve ızgara / Sulu koku tutucu

VEGA LUX Y360°



HM-31359

Style koku tutucu kullanılmaktadır.

Ürün Kodu	Kısa Kod	Çıkış	Ölçü	Fiyat
YAN ÇIKIŞ				
4071.0Y050K.040.1	30049	Ø 50	40 cm	613.40
4071.0Y050K.050.1	30053	Ø 50	50 cm	693.40
4071.0Y050K.060.1	30057	Ø 50	60 cm	766.70
ALT ÇIKIŞ				
4071.0A050K.040.1	30061	Ø 50	40 cm	613.40
4071.0A050K.050.1	30065	Ø 50	50 cm	693.40
4071.0A050K.060.1	30069	Ø 50	60 cm	766.70

Duş kanalı / W200-330-400-500-600-800 mm / Ø 50 yan - alt çıkış
Paslanmaz gövde / Paslanmaz çerçeve ve ızgara / Sulu koku tutucu

VEGA LUX FİLELİ Y360°



HM-31359

Style koku tutucu kullanılmaktadır.

Ürün Kodu	Kısa Kod	Çıkış	Ölçü	Fiyat
YAN ÇIKIŞ				
4068.FY050K.040.1	30792	Ø 50	40 cm	626.70
4068.FY050K.050.1	30796	Ø 50	50 cm	703.40
4068.FY050K.060.1	30800	Ø 50	60 cm	756.70
ALT ÇIKIŞ				
4068.FA050K.040.1	30804	Ø 50	40 cm	626.70
4068.FA050K.050.1	30808	Ø 50	50 cm	703.40
4068.FA050K.060.1	30812	Ø 50	60 cm	756.70

Duş kanalı / W200-330-400-500-600-800 mm / Ø 50 yan - alt çıkış
Paslanmaz gövde / Paslanmaz çerçeve ve ızgara / Sulu koku tutucu



RAIN

KARE

BAHN

SİMPLE ALFA

Ürün Kodu	Kısa Kod	Çıkış	Ölçü		Fiyat
ALT ÇIKIŞ					
4060.0A050K.020.1	29724	Ø 50	20 cm	12	316.70
4060.0A050K.030.1	29726	Ø 50	30 cm	12	403.40
4060.0A050K.040.1	28913	Ø 50	40 cm	12	476.70
4060.0A050K.050.1	28914	Ø 50	50 cm	12	576.70
4060.0A050K.060.1	28915	Ø 50	60 cm	12	653.40

Duş kanalı / W200-330-400-500-600-800 mm / Ø 50 yan - alt çıkış
Paslanmaz gövde / Paslanmaz ızgara / Sulu koku tutucu



HM-31359

Style koku tutucu kullanılmaktadır.

ALFA

Ürün Kodu	Kısa Kod	Çıkış	Ölçü		Fiyat
YAN ÇIKIŞ					
4060.0Y050K.020.1	29723	Ø 50	20 cm	12	380.00
4060.0Y050K.030.1	29725	Ø 50	30 cm	12	466.70
4060.0Y050K.040.1	28919	Ø 50	40 cm	12	543.40
4060.0Y050K.050.1	28920	Ø 50	50 cm	12	640.00
4060.0Y050K.060.1	28921	Ø 50	60 cm	12	716.70
ALT ÇIKIŞ					
4067.0A050K.020.1	31372	Ø 50	20 cm	12	380.00
4067.0A050K.030.1	31373	Ø 50	30 cm	12	466.70
4067.0A050K.040.1	31374	Ø 50	40 cm	12	543.40
4067.0A050K.050.1	31375	Ø 50	50 cm	12	640.00
4067.0A050K.060.1	31376	Ø 50	60 cm	12	716.70

Duş kanalı / W200-330-400-500-600-800 mm / Ø 50 yan - alt çıkış
Paslanmaz gövde / Paslanmaz ızgara / Sulu koku tutucu



HM-31359

Style koku tutucu kullanılmaktadır.

ALFA Y360°

Ürün Kodu	Kısa Kod	Çıkış	Ölçü		Fiyat
YAN ÇIKIŞ					
4064.0Y050K.020.1	30015	Ø 50	20 cm	12	446.70
4064.0Y050K.030.1	30016	Ø 50	30 cm	12	530.00
4064.0Y050K.040.1	30017	Ø 50	40 cm	12	603.40
4064.0Y050K.050.1	30018	Ø 50	50 cm	12	703.40
4064.0Y050K.060.1	30019	Ø 50	60 cm	12	780.00
ALT ÇIKIŞ					
4064.0A050K.020.1	30761	Ø 50	20 cm	12	446.70
4064.0A050K.030.1	30762	Ø 50	30 cm	12	530.00
4064.0A050K.040.1	30763	Ø 50	40 cm	12	603.40
4064.0A050K.050.1	30764	Ø 50	50 cm	12	703.40
4064.0A050K.060.1	30765	Ø 50	60 cm	12	780.00

Duş kanalı / W200-330-400-500-600-800 mm / Ø 50 yan - alt çıkış
Paslanmaz gövde / Paslanmaz ızgara / Sulu koku tutucu



HM-31359

Style koku tutucu kullanılmaktadır.



RAIN



KARE



BAHN



HM-31359

Style koku tutucu kullanılmaktadır.

SIMPLE DELUXE

Ürün Kodu	Kısa Kod	Çıkış	Ölçü		Fiyat
ALT ÇIKIŞ					
4061.0A050K.020.1	29728	Ø 50	20 cm	12	320.00
4061.0A050K.030.1	29730	Ø 50	30 cm	12	406.70
4061.0A050K.040.1	28916	Ø 50	40 cm	12	480.00
4061.0A050K.050.1	28917	Ø 50	50 cm	12	583.40
4061.0A050K.060.1	28918	Ø 50	60 cm	12	660.00

Duş kanalı / W200-330-400-500-600-800 mm / Ø 50 yan - alt çıkış
Paslanmaz gövde / Paslanmaz ızgara / Sulu koku tutucu

DELUXE

Ürün Kodu	Kısa Kod	Çıkış	Ölçü		Fiyat
YAN ÇIKIŞ					
4061.0Y050K.020.1	29727	Ø 50	20 cm	12	383.40
4061.0Y050K.030.1	29729	Ø 50	30 cm	12	470.00
4061.0Y050K.040.1	28922	Ø 50	40 cm	12	546.70
4061.0Y050K.050.1	28923	Ø 50	50 cm	12	646.70
4061.0Y050K.060.1	28924	Ø 50	60 cm	12	723.40
ALT ÇIKIŞ					
4065.0A050K.020.1	31377	Ø 50	20 cm	12	383.40
4065.0A050K.030.1	31378	Ø 50	30 cm	12	470.00
4065.0A050K.040.1	31379	Ø 50	40 cm	12	546.70
4065.0A050K.050.1	31380	Ø 50	50 cm	12	646.70
4065.0A050K.060.1	31381	Ø 50	60 cm	12	723.40

Duş kanalı / W200-330-400-500-600-800 mm / Ø 50 yan - alt çıkış
Paslanmaz gövde / Paslanmaz ızgara / Sulu koku tutucu



HM-31359

Style koku tutucu kullanılmaktadır.

DELUXE Y360°

Ürün Kodu	Kısa Kod	Çıkış	Ölçü		Fiyat
YAN ÇIKIŞ					
4066.0Y050K.020.1	30020	Ø 50	20 cm	12	450.00
4066.0Y050K.030.1	30021	Ø 50	30 cm	12	533.40
4066.0Y050K.040.1	30022	Ø 50	40 cm	12	606.70
4066.0Y050K.050.1	30023	Ø 50	50 cm	12	710.00
4066.0Y050K.060.1	30024	Ø 50	60 cm	12	786.70
ALT ÇIKIŞ					
4066.0A050K.020.1	30766	Ø 50	20 cm	12	450.00
4066.0A050K.030.1	30767	Ø 50	30 cm	12	533.40
4066.0A050K.040.1	30768	Ø 50	40 cm	12	606.70
4066.0A050K.050.1	30769	Ø 50	50 cm	12	710.00
4066.0A050K.060.1	30770	Ø 50	60 cm	12	786.70

Duş kanalı / W200-330-400-500-600-800 mm / Ø 50 yan - alt çıkış
Paslanmaz gövde / Paslanmaz ızgara / Sulu koku tutucu



HM-31359

Style koku tutucu kullanılmaktadır.



RAİN

KARE

BAHN

LINE

Ürün Kodu	Kısa Kod	Çıkış	Ölçü		Fiyat
YAN ÇIKIŞ					
3152.0Y050K.033.1	26499	Ø 50	30 cm	12	260.00
3152.0Y050K.040.1	26500	Ø 50	40 cm	12	290.00
3152.0Y050K.050.1	26501	Ø 50	50 cm	12	346.70
3152.0Y050K.060.1	26502	Ø 50	60 cm	12	376.70
3152.0Y050K.080.1	26503	Ø 50	80 cm	12	440.00
ALT ÇIKIŞ					
3152.0A050K.033.1	26494	Ø 50	30 cm	12	260.00
3152.0A050K.040.1	26495	Ø 50	40 cm	12	290.00
3152.0A050K.050.1	26496	Ø 50	50 cm	12	346.70
3152.0A050K.060.1	26497	Ø 50	60 cm	12	376.70
3152.0A050K.080.1	26498	Ø 50	80 cm	12	440.00

Duş kanalı / W200-330-400-500-600-800 mm / Ø 50 yan - alt çıkış
Plastik gövde / Paslanmaz ızgara / Sulu koku tutucu



HM-27970

Pera koku tutucu kullanılmaktadır.

LINE

Ürün Kodu	Kısa Kod	Çıkış	Ölçü		Fiyat
YAN ÇIKIŞ					
3153.0Y050K.033.1	26509	Ø 50	30 cm	12	260.00
3153.0Y050K.040.1	26510	Ø 50	40 cm	12	290.00
3153.0Y050K.050.1	26511	Ø 50	50 cm	12	346.70
3153.0Y050K.060.1	26512	Ø 50	60 cm	12	376.70
3153.0Y050K.080.1	26513	Ø 50	80 cm	12	440.00
ALT ÇIKIŞ					
3153.0A050K.033.1	26504	Ø 50	30 cm	12	260.00
3153.0A050K.040.1	26505	Ø 50	40 cm	12	290.00
3153.0A050K.050.1	26506	Ø 50	50 cm	12	346.70
3153.0A050K.060.1	26507	Ø 50	60 cm	12	376.70
3153.0A050K.080.1	26508	Ø 50	80 cm	12	440.00

Duş kanalı / W200-330-400-500-600-800 mm / Ø 50 yan - alt çıkış
Plastik gövde / Paslanmaz ızgara / Sulu koku tutucu



HM-27970

Pera koku tutucu kullanılmaktadır.

LINE

Ürün Kodu	Kısa Kod	Çıkış	Ölçü		Fiyat
YAN ÇIKIŞ					
3154.0Y050K.033.1	26519	Ø 50	30 cm	12	260.00
3154.0Y050K.040.1	26520	Ø 50	40 cm	12	290.00
3154.0Y050K.050.1	26521	Ø 50	50 cm	12	346.70
3154.0Y050K.060.1	26522	Ø 50	60 cm	12	376.70
3154.0Y050K.080.1	26523	Ø 50	80 cm	12	440.00
ALT ÇIKIŞ					
3154.0A050K.033.1	26514	Ø 50	30 cm	12	260.00
3154.0A050K.040.1	26515	Ø 50	40 cm	12	290.00
3154.0A050K.050.1	26516	Ø 50	50 cm	12	346.70
3154.0A050K.060.1	26517	Ø 50	60 cm	12	376.70
3154.0A050K.080.1	26518	Ø 50	80 cm	12	440.00

Duş kanalı / W200-330-400-500-600-800 mm / Ø 50 yan - alt çıkış
Plastik gövde / Paslanmaz ızgara / Sulu koku tutucu



HM-27970

Pera koku tutucu kullanılmaktadır.



HM-27970

Pera koku tutucu kullanılmaktadır.



HM-27970

Pera koku tutucu kullanılmaktadır.



HM-27970

Pera koku tutucu kullanılmaktadır.

LINE Y360°

Ürün Kodu	Kısa Kod	Çıkış	Ölçü		Fiyat
YAN ÇIKIŞ					
3150.0Y050K.033.1	30097	Ø 50	30 cm	12	323.40
3150.0Y050K.040.1	30098	Ø 50	40 cm	12	353.40
3150.0Y050K.050.1	30099	Ø 50	50 cm	12	410.00
3150.0Y050K.060.1	30100	Ø 50	60 cm	12	443.40
3150.0Y050K.080.1	30101	Ø 50	80 cm	12	523.40
ALT ÇIKIŞ					
3150.0A050K.033.1	30102	Ø 50	30 cm	12	323.40
3150.0A050K.040.1	30103	Ø 50	40 cm	12	353.40
3150.0A050K.050.1	30104	Ø 50	50 cm	12	410.00
3150.0A050K.060.1	30105	Ø 50	60 cm	12	443.40
3150.0A050K.080.1	30106	Ø 50	80 cm	12	523.40

Duş kanalı / W200-330-400-500-600-800 mm / Ø 50 yan - alt çıkış
Plastik gövde / Paslanmaz ızgara / Sulu koku tutucu

LINE Y360°

Ürün Kodu	Kısa Kod	Çıkış	Ölçü		Fiyat
YAN ÇIKIŞ					
3151.0Y050K.033.1	30107	Ø 50	30 cm	12	323.40
3151.0Y050K.040.1	30108	Ø 50	40 cm	12	353.40
3151.0Y050K.050.1	30109	Ø 50	50 cm	12	410.00
3151.0Y050K.060.1	30110	Ø 50	60 cm	12	443.40
3151.0Y050K.080.1	30111	Ø 50	80 cm	12	523.40
ALT ÇIKIŞ					
3151.0A050K.033.1	30112	Ø 50	30 cm	12	323.40
3151.0A050K.040.1	30113	Ø 50	40 cm	12	353.40
3151.0A050K.050.1	30114	Ø 50	50 cm	12	410.00
3151.0A050K.060.1	30115	Ø 50	60 cm	12	443.40
3151.0A050K.080.1	30116	Ø 50	80 cm	12	523.40

Duş kanalı / W200-330-400-500-600-800 mm / Ø 50 yan - alt çıkış
Plastik gövde / Paslanmaz ızgara / Sulu koku tutucu

LINE Y360°

Ürün Kodu	Kısa Kod	Çıkış	Ölçü		Fiyat
YAN ÇIKIŞ					
3149.0Y050K.033.1	30117	Ø 50	30 cm	12	323.40
3149.0Y050K.040.1	30118	Ø 50	40 cm	12	353.40
3149.0Y050K.050.1	30119	Ø 50	50 cm	12	410.00
3149.0Y050K.060.1	30120	Ø 50	60 cm	12	443.40
3149.0Y050K.080.1	30121	Ø 50	80 cm	12	523.40
ALT ÇIKIŞ					
3149.0A050K.033.1	30122	Ø 50	30 cm	12	323.40
3149.0A050K.040.1	30123	Ø 50	40 cm	12	353.40
3149.0A050K.050.1	30124	Ø 50	50 cm	12	410.00
3149.0A050K.060.1	30125	Ø 50	60 cm	12	443.40
3149.0A050K.080.1	30126	Ø 50	80 cm	12	523.40

Duş kanalı / W200-330-400-500-600-800 mm / Ø 50 yan - alt çıkış
Plastik gövde / Paslanmaz ızgara / Sulu koku tutucu

LINE

Ürün Kodu	Kısa Kod	Çıkış	Ölçü		Fiyat
YAN ÇIKIŞ					
3155.0Y050K.033.1	26529	Ø 50	30 cm	12	283.40
3155.0Y050K.040.1	26530	Ø 50	40 cm	12	320.00
3155.0Y050K.050.1	26531	Ø 50	50 cm	12	380.00
3155.0Y050K.060.1	26532	Ø 50	60 cm	12	416.70
3155.0Y050K.080.1	26533	Ø 50	80 cm	12	506.70
ALT ÇIKIŞ					
3155.0A050K.033.1	26524	Ø 50	30 cm	12	283.40
3155.0A050K.040.1	26525	Ø 50	40 cm	12	320.00
3155.0A050K.050.1	26526	Ø 50	50 cm	12	380.00
3155.0A050K.060.1	26527	Ø 50	60 cm	12	416.70
3155.0A050K.080.1	26528	Ø 50	80 cm	12	506.70

Duş kanalı / W200-330-400-500-600-800 mm / Ø 50 yan - alt çıkış
Plastik gövde / Paslanmaz ızgara / Sulu koku tutucu



HM-27970

Pera koku tutucu kullanılmaktadır.

LINE

Ürün Kodu	Kısa Kod	Çıkış	Ölçü		Fiyat
YAN ÇIKIŞ					
3156.0Y050K.033.1	26549	Ø 50	30 cm	12	283.40
3156.0Y050K.040.1	26550	Ø 50	40 cm	12	320.00
3156.0Y050K.050.1	26551	Ø 50	50 cm	12	380.00
3156.0Y050K.060.1	26552	Ø 50	60 cm	12	416.70
3156.0Y050K.080.1	26553	Ø 50	80 cm	12	506.70
ALT ÇIKIŞ					
3156.0A050K.033.1	26544	Ø 50	30 cm	12	283.40
3156.0A050K.040.1	26545	Ø 50	40 cm	12	320.00
3156.0A050K.050.1	26546	Ø 50	50 cm	12	380.00
3156.0A050K.060.1	26547	Ø 50	60 cm	12	416.70
3156.0A050K.080.1	26548	Ø 50	80 cm	12	506.70

Duş kanalı / W200-330-400-500-600-800 mm / Ø 50 yan - alt çıkış
Plastik gövde / Paslanmaz ızgara / Sulu koku tutucu



HM-27970

Pera koku tutucu kullanılmaktadır.

LINE

Ürün Kodu	Kısa Kod	Çıkış	Ölçü		Fiyat
YAN ÇIKIŞ					
3157.0Y050K.033.1	26569	Ø 50	30 cm	12	283.40
3157.0Y050K.040.1	26570	Ø 50	40 cm	12	320.00
3157.0Y050K.050.1	26571	Ø 50	50 cm	12	380.00
3157.0Y050K.060.1	26572	Ø 50	60 cm	12	416.70
3157.0Y050K.080.1	26575	Ø 50	80 cm	12	506.70
ALT ÇIKIŞ					
3157.0A050K.033.1	26564	Ø 50	30 cm	12	283.40
3157.0A050K.040.1	26565	Ø 50	40 cm	12	320.00
3157.0A050K.050.1	26566	Ø 50	50 cm	12	380.00
3157.0A050K.060.1	26567	Ø 50	60 cm	12	416.70
3157.0A050K.080.1	26568	Ø 50	80 cm	12	506.70

Duş kanalı / W200-330-400-500-600-800 mm / Ø 50 yan - alt çıkış
Plastik gövde / Paslanmaz ızgara / Sulu koku tutucu



HM-27970

Pera koku tutucu kullanılmaktadır.

LINE Y360°

Ürün Kodu	Kısa Kod	Çıkış	Ölçü		Fiyat
YAN ÇIKIŞ					
3148.0Y050K.033.1	30127	Ø 50	30 cm	12	350.00
3148.0Y050K.040.1	30128	Ø 50	40 cm	12	386.70
3148.0Y050K.050.1	30129	Ø 50	50 cm	12	443.40
3148.0Y050K.060.1	30130	Ø 50	60 cm	12	480.00
3148.0Y050K.080.1	30131	Ø 50	80 cm	12	556.70
ALT ÇIKIŞ					
3148.0A050K.033.1	30132	Ø 50	30 cm	12	350.00
3148.0A050K.040.1	30133	Ø 50	40 cm	12	386.70
3148.0A050K.050.1	30134	Ø 50	50 cm	12	443.40
3148.0A050K.060.1	30135	Ø 50	60 cm	12	480.00
3148.0A050K.080.1	30136	Ø 50	80 cm	12	556.70

Duş kanalı / W200-330-400-500-600-800 mm / Ø 50 yan - alt çıkış
Plastik gövde / Paslanmaz ızgara / Sulu koku tutucu



HM-27970
Pera koku tutucu kullanılmaktadır.

LINE Y360°

Ürün Kodu	Kısa Kod	Çıkış	Ölçü		Fiyat
YAN ÇIKIŞ					
3146.0Y050K.033.1	30147	Ø 50	30 cm	12	350.00
3146.0Y050K.040.1	30148	Ø 50	40 cm	12	386.70
3146.0Y050K.050.1	30149	Ø 50	50 cm	12	443.40
3146.0Y050K.060.1	30150	Ø 50	60 cm	12	480.00
3146.0Y050K.080.1	30151	Ø 50	80 cm	12	556.70
ALT ÇIKIŞ					
3146.0A050K.033.1	30152	Ø 50	30 cm	12	350.00
3146.0A050K.040.1	30153	Ø 50	40 cm	12	386.70
3146.0A050K.050.1	30154	Ø 50	50 cm	12	443.40
3146.0A050K.060.1	30155	Ø 50	60 cm	12	480.00
3146.0A050K.080.1	30156	Ø 50	80 cm	12	556.70

Duş kanalı / W200-330-400-500-600-800 mm / Ø 50 yan - alt çıkış
Plastik gövde / Paslanmaz ızgara / Sulu koku tutucu



HM-27970
Pera koku tutucu kullanılmaktadır.

LINE Y360°

Ürün Kodu	Kısa Kod	Çıkış	Ölçü		Fiyat
YAN ÇIKIŞ					
3160.0Y050K.033.1	30157	Ø 50	30 cm	12	350.00
3160.0Y050K.040.1	30158	Ø 50	40 cm	12	386.70
3160.0Y050K.050.1	30159	Ø 50	50 cm	12	443.40
3160.0Y050K.060.1	30160	Ø 50	60 cm	12	480.00
3160.0Y050K.080.1	30161	Ø 50	80 cm	12	556.70
ALT ÇIKIŞ					
3160.0A050K.033.1	30162	Ø 50	30 cm	12	350.00
3160.0A050K.040.1	30163	Ø 50	40 cm	12	386.70
3160.0A050K.050.1	30164	Ø 50	50 cm	12	443.40
3160.0A050K.060.1	30165	Ø 50	60 cm	12	480.00
3160.0A050K.080.1	30166	Ø 50	80 cm	12	556.70

Duş kanalı / W200-330-400-500-600-800 mm / Ø 50 yan - alt çıkış
Plastik gövde / Paslanmaz ızgara / Sulu koku tutucu



HM-27970
Pera koku tutucu kullanılmaktadır.

LINE T.M.

Ürün Kodu	Kısa Kod	Çıkış	Ölçü		Fiyat
YAN ÇIKIŞ					
3155.TY050K.033.1	26539	Ø 50	30 cm	12	343.40
3155.TY050K.040.1	26540	Ø 50	40 cm	12	386.70
3155.TY050K.050.1	26541	Ø 50	50 cm	12	453.40
3155.TY050K.060.1	26542	Ø 50	60 cm	12	500.00
3155.TY050K.080.1	26543	Ø 50	80 cm	12	600.00

ALT ÇIKIŞ

3155.TA050K.033.1	26534	Ø 50	30 cm	12	343.40
3155.TA050K.040.1	26535	Ø 50	40 cm	12	386.70
3155.TA050K.050.1	26536	Ø 50	50 cm	12	453.40
3155.TA050K.060.1	26537	Ø 50	60 cm	12	500.00
3155.TA050K.080.1	26538	Ø 50	80 cm	12	600.00

Duş kanalı / W200-330-400-500-600-800 mm / Ø 50 yan - alt çıkış
Plastik gövde / Paslanmaz ızgara / Sulu koku tutucu



HM-27970

Pera koku tutucu kullanılmaktadır.

LINE T.M.

Ürün Kodu	Kısa Kod	Çıkış	Ölçü		Fiyat
YAN ÇIKIŞ					
3156.TY050K.033.1	26559	Ø 50	30 cm	12	343.40
3156.TY050K.040.1	26560	Ø 50	40 cm	12	386.70
3156.TY050K.050.1	26561	Ø 50	50 cm	12	453.40
3156.TY050K.060.1	26562	Ø 50	60 cm	12	500.00
3156.TY050K.080.1	26563	Ø 50	80 cm	12	600.00

ALT ÇIKIŞ

3156.TA050K.033.1	26554	Ø 50	30 cm	12	343.40
3156.TA050K.040.1	26555	Ø 50	40 cm	12	386.70
3156.TA050K.050.1	26556	Ø 50	50 cm	12	453.40
3156.TA050K.060.1	26557	Ø 50	60 cm	12	500.00
3156.TA050K.080.1	26558	Ø 50	80 cm	12	600.00

Duş kanalı / W200-330-400-500-600-800 mm / Ø 50 yan - alt çıkış
Plastik gövde / Paslanmaz ızgara / Sulu koku tutucu



HM-27970

Pera koku tutucu kullanılmaktadır.

LINE T.M.

Ürün Kodu	Kısa Kod	Çıkış	Ölçü		Fiyat
YAN ÇIKIŞ					
3157.TY050K.033.1	26581	Ø 50	30 cm	12	343.40
3157.TY050K.040.1	26582	Ø 50	40 cm	12	386.70
3157.TY050K.050.1	26584	Ø 50	50 cm	12	453.40
3157.TY050K.060.1	26585	Ø 50	60 cm	12	500.00
3157.TY050K.080.1	26586	Ø 50	80 cm	12	600.00

ALT ÇIKIŞ

3157.TA050K.033.1	26576	Ø 50	30 cm	12	343.40
3157.TA050K.040.1	26577	Ø 50	40 cm	12	386.70
3157.TA050K.050.1	26578	Ø 50	50 cm	12	453.40
3157.TA050K.060.1	26579	Ø 50	60 cm	12	500.00
3157.TA050K.080.1	26580	Ø 50	80 cm	12	600.00

Duş kanalı / W200-330-400-500-600-800 mm / Ø 50 yan - alt çıkış
Plastik gövde / Paslanmaz ızgara / Sulu koku tutucu



HM-27970

Pera koku tutucu kullanılmaktadır.

LINE T.M. Y360°



HM-27970

Pera koku tutucu kullanılmaktadır.

Ürün Kodu	Kısa Kod	Çıkış	Ölçü		Fiyat
YAN ÇIKIŞ					
3168.TY050K.033.1	30207	Ø 50	30 cm	12	396.70
3168.TY050K.040.1	30208	Ø 50	40 cm	12	440.00
3168.TY050K.050.1	30209	Ø 50	50 cm	12	500.00
3168.TY050K.060.1	30210	Ø 50	60 cm	12	546.70
3168.TY050K.080.1	30211	Ø 50	80 cm	12	626.70
ALT ÇIKIŞ					
3168.TA050K.033.1	30212	Ø 50	30 cm	12	396.70
3168.TA050K.040.1	30213	Ø 50	40 cm	12	440.00
3168.TA050K.050.1	30214	Ø 50	50 cm	12	500.00
3168.TA050K.060.1	30215	Ø 50	60 cm	12	546.70
3168.TA050K.080.1	30216	Ø 50	80 cm	12	626.70

Duş kanalı / W200-330-400-500-600-800 mm / Ø 50 yan - alt çıkış
Plastik gövde / Paslanmaz ızgara / Sulu koku tutucu

LINE T.M. Y360°



HM-27970

Pera koku tutucu kullanılmaktadır.

Ürün Kodu	Kısa Kod	Çıkış	Ölçü		Fiyat
YAN ÇIKIŞ					
3169.TY050K.033.1	30217	Ø 50	30 cm	12	396.70
3169.TY050K.040.1	30218	Ø 50	40 cm	12	440.00
3169.TY050K.050.1	30219	Ø 50	50 cm	12	500.00
3169.TY050K.060.1	30220	Ø 50	60 cm	12	546.70
3169.TY050K.080.1	30221	Ø 50	80 cm	12	626.70
ALT ÇIKIŞ					
3169.TA050K.033.1	30222	Ø 50	30 cm	12	396.70
3169.TA050K.040.1	30223	Ø 50	40 cm	12	440.00
3169.TA050K.050.1	30224	Ø 50	50 cm	12	500.00
3169.TA050K.060.1	30225	Ø 50	60 cm	12	546.70
3169.TA050K.080.1	30226	Ø 50	80 cm	12	626.70

Duş kanalı / W200-330-400-500-600-800 mm / Ø 50 yan - alt çıkış
Plastik gövde / Paslanmaz ızgara / Sulu koku tutucu

LINE T.M. Y360°



HM-27970

Pera koku tutucu kullanılmaktadır.

Ürün Kodu	Kısa Kod	Çıkış	Ölçü		Fiyat
YAN ÇIKIŞ					
3170.TY050K.033.1	30227	Ø 50	30 cm	12	396.70
3170.TY050K.040.1	30228	Ø 50	40 cm	12	440.00
3170.TY050K.050.1	30229	Ø 50	50 cm	12	500.00
3170.TY050K.060.1	30230	Ø 50	60 cm	12	546.70
3170.TY050K.080.1	30231	Ø 50	80 cm	12	626.70
ALT ÇIKIŞ					
3170.TA050K.033.1	30232	Ø 50	30 cm	12	396.70
3170.TA050K.040.1	30233	Ø 50	40 cm	12	440.00
3170.TA050K.050.1	30234	Ø 50	50 cm	12	500.00
3170.TA050K.060.1	30235	Ø 50	60 cm	12	546.70
3170.TA050K.080.1	30236	Ø 50	80 cm	12	626.70

Duş kanalı / W200-330-400-500-600-800 mm / Ø 50 yan - alt çıkış
Plastik gövde / Paslanmaz ızgara / Sulu koku tutucu

LEGAL

Ürün Kodu	Kısa Kod	Çıkış	Ölçü		Fiyat
YAN ÇIKIŞ					
3158.0Y050K.033.1	26595	Ø 50	30 cm	12	433.40
3158.0Y050K.040.1	26596	Ø 50	40 cm	12	503.40
3158.0Y050K.050.1	26597	Ø 50	50 cm	12	636.70
3158.0Y050K.060.1	26598	Ø 50	60 cm	12	710.00
3158.0Y050K.080.1	26599	Ø 50	80 cm	12	863.40
ALT ÇIKIŞ					
3158.0A050K.033.1	26587	Ø 50	30 cm	12	433.40
3158.0A050K.040.1	26588	Ø 50	40 cm	12	503.40
3158.0A050K.050.1	26592	Ø 50	50 cm	12	636.70
3158.0A050K.060.1	26593	Ø 50	60 cm	12	710.00
3158.0A050K.080.1	26594	Ø 50	80 cm	12	863.40

Duş kanalı / W200-330-400-500-600-800 mm / Ø 50 yan - alt çıkış
Paslanmaz gövde / Paslanmaz ızgara / Sulu koku tutucu



HM-27970

Pera koku tutucu kullanılmaktadır.

LEGAL

Ürün Kodu	Kısa Kod	Çıkış	Ölçü		Fiyat
YAN ÇIKIŞ					
3159.0Y050K.033.1	26615	Ø 50	30 cm	12	433.40
3159.0Y050K.040.1	26616	Ø 50	40 cm	12	503.40
3159.0Y050K.050.1	26617	Ø 50	50 cm	12	636.70
3159.0Y050K.060.1	26618	Ø 50	60 cm	12	710.00
3159.0Y050K.080.1	26619	Ø 50	80 cm	12	863.40
ALT ÇIKIŞ					
3159.0A050K.033.1	26610	Ø 50	30 cm	12	433.40
3159.0A050K.040.1	26611	Ø 50	40 cm	12	503.40
3159.0A050K.050.1	26612	Ø 50	50 cm	12	636.70
3159.0A050K.060.1	26613	Ø 50	60 cm	12	710.00
3159.0A050K.080.1	26614	Ø 50	80 cm	12	863.40

Duş kanalı / W200-330-400-500-600-800 mm / Ø 50 yan - alt çıkış
Paslanmaz gövde / Paslanmaz ızgara / Sulu koku tutucu



HM-27970

Pera koku tutucu kullanılmaktadır.

DELUXE

Ürün Kodu	Kısa Kod	Çıkış	Ölçü		Fiyat
YAN ÇIKIŞ					
3163.0Y050K.033.1	28952	Ø 50	30 cm	12	473.40
3163.0Y050K.040.1	28953	Ø 50	40 cm	12	523.40
3163.0Y050K.050.1	28954	Ø 50	50 cm	12	616.70
3163.0Y050K.060.1	28955	Ø 50	60 cm	12	696.70
3163.0Y050K.080.1	28956	Ø 50	80 cm	12	856.70
ALT ÇIKIŞ					
3163.0A050K.033.1	28957	Ø 50	30 cm	12	473.40
3163.0A050K.040.1	28958	Ø 50	40 cm	12	523.40
3163.0A050K.050.1	28959	Ø 50	50 cm	12	616.70
3163.0A050K.060.1	28960	Ø 50	60 cm	12	696.70
3163.0A050K.080.1	28961	Ø 50	80 cm	12	856.70

Duş kanalı / W200-330-400-500-600-800 mm / Ø 50 yan - alt çıkış
Paslanmaz gövde / Paslanmaz ızgara / Sulu koku tutucu



HM-27970

Pera koku tutucu kullanılmaktadır.

LEGAL Y360°



HM-27970

Pera koku tutucu kullanılmaktadır.

Ürün Kodu	Kısa Kod	Çıkış	Ölçü		Fiyat
YAN ÇIKIŞ					
3161.0Y050K.033.1	30167	Ø 50	30 cm	12	510.00
3161.0Y050K.040.1	30168	Ø 50	40 cm	12	580.00
3161.0Y050K.050.1	30169	Ø 50	50 cm	12	713.40
3161.0Y050K.060.1	30170	Ø 50	60 cm	12	790.00
3161.0Y050K.080.1	30171	Ø 50	80 cm	12	930.00
ALT ÇIKIŞ					
3161.0A050K.033.1	30172	Ø 50	30 cm	12	510.00
3161.0A050K.040.1	30173	Ø 50	40 cm	12	580.00
3161.0A050K.050.1	30174	Ø 50	50 cm	12	713.40
3161.0A050K.060.1	30175	Ø 50	60 cm	12	790.00
3161.0A050K.080.1	30176	Ø 50	80 cm	12	930.00

Duş kanalı / W200-330-400-500-600-800 mm / Ø 50 yan - alt çıkış
Paslanmaz gövde / Paslanmaz ızgara / Sulu koku tutucu

LEGAL Y360°



HM-27970

Pera koku tutucu kullanılmaktadır.

Ürün Kodu	Kısa Kod	Çıkış	Ölçü		Fiyat
YAN ÇIKIŞ					
3167.0Y050K.033.1	30197	Ø 50	30 cm	12	510.00
3167.0Y050K.040.1	30198	Ø 50	40 cm	12	580.00
3167.0Y050K.050.1	30199	Ø 50	50 cm	12	713.40
3167.0Y050K.060.1	30200	Ø 50	60 cm	12	790.00
3167.0Y050K.080.1	30201	Ø 50	80 cm	12	930.00
ALT ÇIKIŞ					
3167.0A050K.033.1	30202	Ø 50	30 cm	12	510.00
3167.0A050K.040.1	30203	Ø 50	40 cm	12	580.00
3167.0A050K.050.1	30204	Ø 50	50 cm	12	713.40
3167.0A050K.060.1	30205	Ø 50	60 cm	12	790.00
3167.0A050K.080.1	30206	Ø 50	80 cm	12	930.00

Duş kanalı / W200-330-400-500-600-800 mm / Ø 50 yan - alt çıkış
Paslanmaz gövde / Paslanmaz ızgara / Sulu koku tutucu

DELUXE Y360°



HM-27970

Pera koku tutucu kullanılmaktadır.

Ürün Kodu	Kısa Kod	Çıkış	Ölçü		Fiyat
YAN ÇIKIŞ					
3164.0Y050K.033.1	30177	Ø 50	30 cm	12	556.70
3164.0Y050K.040.1	30178	Ø 50	40 cm	12	606.70
3164.0Y050K.050.1	30179	Ø 50	50 cm	12	700.00
3164.0Y050K.060.1	30180	Ø 50	60 cm	12	783.40
3164.0Y050K.080.1	30181	Ø 50	80 cm	12	930.00
ALT ÇIKIŞ					
3164.0A050K.033.1	30182	Ø 50	30 cm	12	556.70
3164.0A050K.040.1	30183	Ø 50	40 cm	12	606.70
3164.0A050K.050.1	30184	Ø 50	50 cm	12	700.00
3164.0A050K.060.1	30185	Ø 50	60 cm	12	783.40
3164.0A050K.080.1	30186	Ø 50	80 cm	12	930.00

Duş kanalı / W200-330-400-500-600-800 mm / Ø 50 yan - alt çıkış
Paslanmaz gövde / Paslanmaz ızgara / Sulu koku tutucu

LEGAL T.M.

Ürün Kodu	Kısa Kod	Çıkış	Ölçü		Fiyat
YAN ÇIKIŞ					
3158.TY050K.033.1	26604	Ø 50	30 cm	12	486.70
3158.TY050K.040.1	26605	Ø 50	40 cm	12	563.40
3158.TY050K.050.1	26606	Ø 50	50 cm	12	706.70
3158.TY050K.060.1	26607	Ø 50	60 cm	12	790.00
3158.TY050K.080.1	26608	Ø 50	80 cm	12	950.00
ALT ÇIKIŞ					
3158.TA050K.033.1	26609	Ø 50	30 cm	12	486.70
3158.TA050K.040.1	26600	Ø 50	40 cm	12	563.40
3158.TA050K.050.1	26601	Ø 50	50 cm	12	706.70
3158.TA050K.060.1	26602	Ø 50	60 cm	12	790.00
3158.TA050K.080.1	26603	Ø 50	80 cm	12	950.00

Duş kanalı / W200-330-400-500-600-800 mm / Ø 50 yan - alt çıkış
Paslanmaz gövde / Paslanmaz ızgara / Sulu koku tutucu

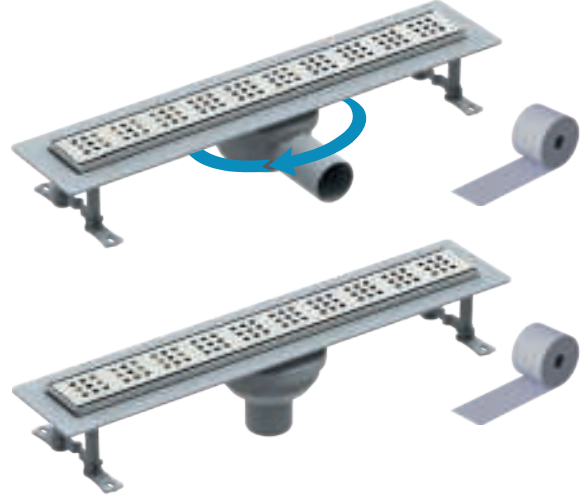

HM-27970

Pera koku tutucu kullanılmaktadır.

LEGAL T.M.

Ürün Kodu	Kısa Kod	Çıkış	Ölçü		Fiyat
YAN ÇIKIŞ					
3159.TY050K.033.1	26625	Ø 50	30 cm	12	486.70
3159.TY050K.040.1	26626	Ø 50	40 cm	12	563.40
3159.TY050K.050.1	26627	Ø 50	50 cm	12	706.70
3159.TY050K.060.1	26628	Ø 50	60 cm	12	790.00
3159.TY050K.080.1	26629	Ø 50	80 cm	12	950.00
ALT ÇIKIŞ					
3159.TA050K.033.1	26620	Ø 50	30 cm	12	486.70
3159.TA050K.040.1	26621	Ø 50	40 cm	12	563.40
3159.TA050K.050.1	26622	Ø 50	50 cm	12	706.70
3159.TA050K.060.1	26623	Ø 50	60 cm	12	790.00
3159.TA050K.080.1	26624	Ø 50	80 cm	12	950.00

Duş kanalı / W200-330-400-500-600-800 mm / Ø 50 yan - alt çıkış
Paslanmaz gövde / Paslanmaz ızgara / Sulu koku tutucu

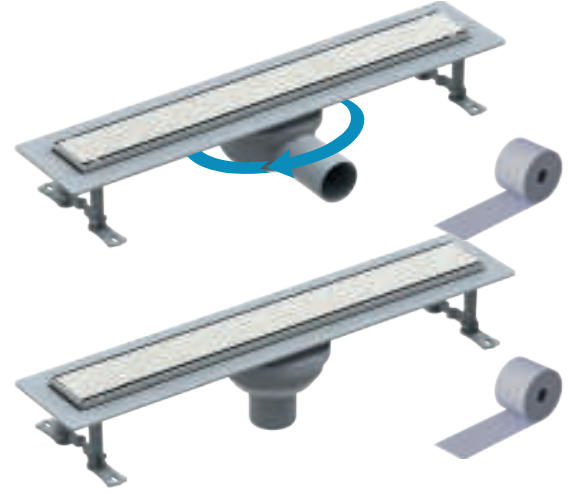

HM-27970

Pera koku tutucu kullanılmaktadır.

LINE FİLELİ

Ürün Kodu	Kısa Kod	Çıkış	Ölçü		Fiyat
YAN ÇIKIŞ					
3155.FY050K.033.1	27366	Ø 50	30 cm	12	303.40
3155.FY050K.040.1	27367	Ø 50	40 cm	12	353.40
3155.FY050K.050.1	27368	Ø 50	50 cm	12	413.40
3155.FY050K.060.1	27369	Ø 50	60 cm	12	446.70
3155.FY050K.080.1	27370	Ø 50	80 cm	12	540.00
ALT ÇIKIŞ					
3155.FA050K.033.1	27371	Ø 50	30 cm	12	303.40
3155.FA050K.040.1	37372	Ø 50	40 cm	12	353.40
3155.FA050K.050.1	37373	Ø 50	50 cm	12	413.40
3155.FA050K.060.1	37374	Ø 50	60 cm	12	446.70
3155.FA050K.080.1	37375	Ø 50	80 cm	12	540.00

Duş kanalı / W200-330-400-500-600-800 mm / Ø 50 yan - alt çıkış
Paslanmaz gövde / Paslanmaz ızgara / Sulu koku tutucu



HM-27970

Pera koku tutucu kullanılmaktadır.

LEGAL T.M. Y360°



HM-27970

Pera koku tutucu kullanılmaktadır.

Ürün Kodu	Kısa Kod	Çıkış	Ölçü		Fiyat
YAN ÇIKIŞ					
3171.TY050K.033.1	30237	Ø 50	30 cm	12	560.00
3171.TY050K.040.1	30238	Ø 50	40 cm	12	636.70
3171.TY050K.050.1	30239	Ø 50	50 cm	12	780.00
3171.TY050K.060.1	30240	Ø 50	60 cm	12	863.40
3171.TY050K.080.1	30241	Ø 50	80 cm	12	1006.70
ALT ÇIKIŞ					
3171.TA050K.033.1	30242	Ø 50	30 cm	12	560.00
3171.TA050K.040.1	30243	Ø 50	40 cm	12	636.70
3171.TA050K.050.1	30244	Ø 50	50 cm	12	780.00
3171.TA050K.060.1	30245	Ø 50	60 cm	12	863.40
3171.TA050K.080.1	30246	Ø 50	80 cm	12	1006.70

Duş kanalı / W200-330-400-500-600-800 mm / Ø 50 yan - alt çıkış
Paslanmaz gövde / Paslanmaz ızgara / Sulu koku tutucu

LEGAL T.M. Y360°



HM-27970

Pera koku tutucu kullanılmaktadır.

Ürün Kodu	Kısa Kod	Çıkış	Ölçü		Fiyat
YAN ÇIKIŞ					
3172.TY050K.033.1	30247	Ø 50	30 cm	12	560.00
3172.TY050K.040.1	30248	Ø 50	40 cm	12	636.70
3172.TY050K.050.1	30249	Ø 50	50 cm	12	780.00
3172.TY050K.060.1	30250	Ø 50	60 cm	12	863.40
3172.TY050K.080.1	30251	Ø 50	80 cm	12	1006.70
ALT ÇIKIŞ					
3172.TA050K.033.1	30252	Ø 50	30 cm	12	560.00
3172.TA050K.040.1	30253	Ø 50	40 cm	12	636.70
3172.TA050K.050.1	30254	Ø 50	50 cm	12	780.00
3172.TA050K.060.1	30255	Ø 50	60 cm	12	863.40
3172.TA050K.080.1	30256	Ø 50	80 cm	12	1006.70

Duş kanalı / W200-330-400-500-600-800 mm / Ø 50 yan - alt çıkış
Paslanmaz gövde / Paslanmaz ızgara / Sulu koku tutucu

LINE FİLELİ Y360°



HM-27970

Pera koku tutucu kullanılmaktadır.

Ürün Kodu	Kısa Kod	Çıkış	Ölçü		Fiyat
YAN ÇIKIŞ					
3147.FY050K.033.1	30137	Ø 50	30 cm	12	366.70
3147.FY050K.040.1	30138	Ø 50	40 cm	12	416.70
3147.FY050K.050.1	30139	Ø 50	50 cm	12	470.00
3147.FY050K.060.1	30140	Ø 50	60 cm	12	506.70
3147.FY050K.080.1	30141	Ø 50	80 cm	12	583.40
ALT ÇIKIŞ					
3147.FA050K.033.1	30142	Ø 50	30 cm	12	366.70
3147.FA050K.040.1	30143	Ø 50	40 cm	12	416.70
3147.FA050K.050.1	30144	Ø 50	50 cm	12	470.00
3147.FA050K.060.1	30145	Ø 50	60 cm	12	506.70
3147.FA050K.080.1	30146	Ø 50	80 cm	12	583.40

Duş kanalı / W200-330-400-500-600-800 mm / Ø 50 yan - alt çıkış
Paslanmaz gövde / Paslanmaz ızgara / Sulu koku tutucu

LINE

Ürün Kodu	Kısa Kod	Çıkış	Ölçü		Fiyat
ALÇAK SEVİYELİ YAN ÇIKIŞ					
4022.0Y050A.033.1	22310	Ø 50	33 cm	12	340.00
4022.0Y050A.040.1	22382	Ø 50	40 cm	12	370.00
4022.0Y050A.050.1	22391	Ø 50	50 cm	12	433.40
4022.0Y050A.060.1	22400	Ø 50	60 cm	12	476.70
4022.0Y050A.080.1	22409	Ø 50	80 cm	12	556.70
ALÇAK SEVİYELİ ALT ÇIKIŞ					
4022.0A050A.033.1	22418	Ø 50	33 cm	12	340.00
4022.0A050A.040.1	22426	Ø 50	40 cm	12	370.00
4022.0A050A.050.1	22435	Ø 50	50 cm	12	433.40
4022.0A050A.060.1	22446	Ø 50	60 cm	12	476.70
4022.0A050A.080.1	22459	Ø 50	80 cm	12	556.70

Duş kanalı / W200-330-400-500-600 mm / Ø 50 yan - alt çıkış
Plastik gövde / Paslanmaz ızgara / Sulu koku tutucu

LINE

Ürün Kodu	Kısa Kod	Çıkış	Ölçü		Fiyat
YAN ÇIKIŞ					
4022.0Y050K.033.1	16126	Ø 50	30 cm	12	340.00
4022.0Y050K.040.1	16138	Ø 50	40 cm	12	370.00
4022.0Y050K.050.1	16157	Ø 50	50 cm	12	433.40
4022.0Y050K.060.1	16168	Ø 50	60 cm	12 <td 476.70	
4022.0Y050K.080.1	16178	Ø 50	80 cm	12	556.70
ALT ÇIKIŞ					
4022.0A050K.033.1	16159	Ø 50	30 cm	12	340.00
4022.0A050K.040.1	16187	Ø 50	40 cm	12	370.00
4022.0A050K.050.1	16207	Ø 50	50 cm	12	433.40
4022.0A050K.060.1	16231	Ø 50	60 cm	12	476.70
4022.0A050K.080.1	16249	Ø 50	80 cm	12	556.70

Duş kanalı / W200-330-400-500-600-800 mm / Ø 50 yan - alt çıkış
Plastik gövde / Paslanmaz ızgara / Sulu koku tutucu

LINE T.M.

Ürün Kodu	Kısa Kod	Çıkış	Ölçü		Fiyat
YAN ÇIKIŞ					
4022.TY050K.033.1	16268	Ø 50	33 cm	12	366.70
4022.TY050K.040.1	16283	Ø 50	40 cm	12	416.70
4022.TY050K.050.1	16298	Ø 50	50 cm	12	480.00
4022.TY050K.060.1	16312	Ø 50	60 cm	12	516.70
4022.TY050K.080.1	16332	Ø 50	80 cm	12	606.70
ALT ÇIKIŞ					
4022.TA050K.033.1	16363	Ø 50	33 cm	12	366.70
4022.TA050K.040.1	16395	Ø 50	40 cm	12	416.70
4022.TA050K.050.1	16413	Ø 50	50 cm	12	480.00
4022.TA050K.060.1	16436	Ø 50	60 cm	12	516.70
4022.TA050K.080.1	16451	Ø 50	80 cm	12	606.70

Duş kanalı / W200-330-400-500-600-800 mm / Ø 50 yan - alt çıkış
Plastik gövde / Paslanmaz ızgara / Sulu koku tutucu



HM-31362

Kısa koku tutucu kullanılmaktadır.



HM-31361

Uzun koku tutucu kullanılmaktadır.

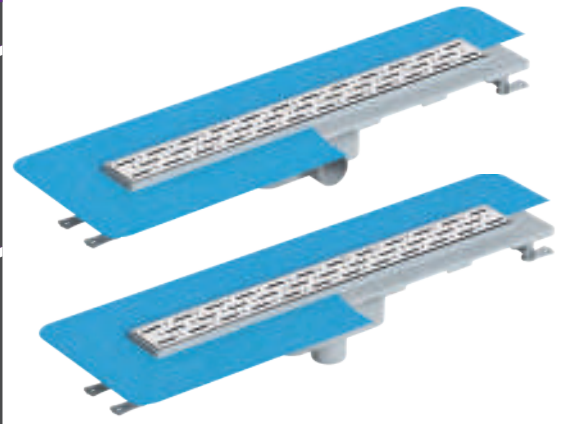

HM-31361

Uzun koku tutucu kullanılmaktadır.



RAIN



KARE



BAHN

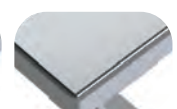

DOLU



HM-31361

Uzun koku tutucu kullanılmaktadır.

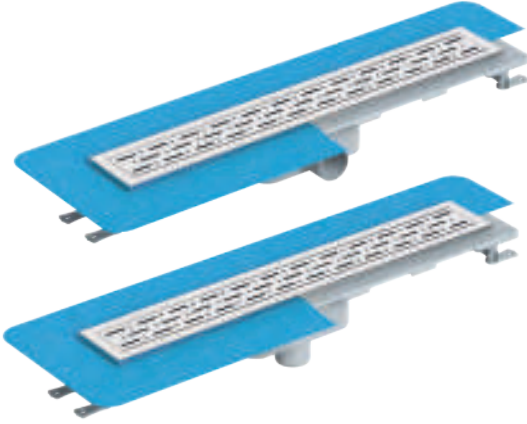

HM-31361

Uzun koku tutucu kullanılmaktadır.

PARÇANO	PARÇA AÇIKLAMASI	MALZEME	ADET
4016.1	Plastik Alt Gövde	ABS	1
4016.2	Koku Tutucu	ABS	1
4016.3	Paslanmaz Izgara	AISI 304	1
4016.4	Yükseklik Ayarlı Montaj Seti	PP	2

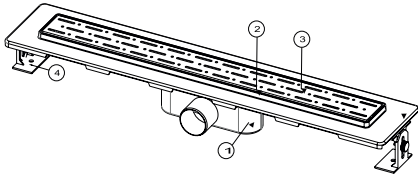

ÜRÜN KODU	W	L	H	Ø D	A	B	C	X	E	B1	A1
4016.0Y050K.033.1	423	134	72	49.5	360	88.9	11.35	385	1	56	325
4016.0Y050K.040.1	492	134	72	49.5	430	88.9	11.35	456	1	56	395
4016.0Y050K.050.1	592	134	72	49.5	530	88.9	11.35	556	1	56	495
4016.0Y050K.060.1	693	134	72	49.5	630	88.9	11.35	656	1	56	595
4016.0Y050K.080.1	893	134	72	49.5	830	88.9	11.35	856	1	56	795

ÜRÜN KODU	W	L	H	Ø D	A	B	C	X	E	B1	A1
4016.0A050K.033.1	423	134	100	49.5	360	88.9	11.35	385	1	56	325
4016.0A050K.040.1	492	134	100	49.5	430	88.9	11.35	456	1	56	395
4016.0A050K.050.1	592	134	100	49.5	530	88.9	11.35	556	1	56	495
4016.0A050K.060.1	693	134	100	49.5	630	88.9	11.35	656	1	56	595
4016.0A050K.080.1	893	134	100	49.5	830	88.9	11.35	856	1	56	795

Tablo ölçü birimi "mm"dir.

DELUXE

Ürün Kodu	Kısa Kod	Çıkış	Ölçü		Fiyat
YAN ÇIKIŞ					
4016.0Y050K.033.1	16462	Ø 50	33 cm	12	516.70
4016.0Y050K.040.1	16486	Ø 50	40 cm	12	553.40
4016.0Y050K.050.1	16497	Ø 50	50 cm	12	650.00
4016.0Y050K.060.1	16512	Ø 50	60 cm	12	736.70
4016.0Y050K.080.1	16527	Ø 50	80 cm	12	886.70
ALT ÇIKIŞ					
4016.0A050K.033.1	16542	Ø 50	33 cm	12	516.70
4016.0A050K.040.1	16570	Ø 50	40 cm	12	553.40
4016.0A050K.050.1	16592	Ø 50	50 cm	12	650.00
4016.0A050K.060.1	16608	Ø 50	60 cm	12	736.70
4016.0A050K.080.1	16625	Ø 50	80 cm	12	886.70

Duş kanalı / W200-330-400-500-600 mm / Ø 50 yan - alt çıkış
Plastik gövde / Paslanmaz ızgara ve çerçeve / Sulu koku tutucu

DELUXE T.M.

Ürün Kodu	Kısa Kod	Çıkış	Ölçü		Fiyat
YAN ÇIKIŞ					
4016.TY050K.033.1	16555	Ø 50	30 cm	12	550.00
4016.TY050K.040.1	16572	Ø 50	40 cm	12	606.70
4016.TY050K.050.1	16587	Ø 50	50 cm	12	703.40
4016.TY050K.060.1	16604	Ø 50	60 cm	12	780.00
4016.TY050K.080.1	16634	Ø 50	80 cm	12	943.40
ALT ÇIKIŞ					
4016.TA050K.033.1	16643	Ø 50	30 cm	12	550.00
4016.TA050K.040.1	16666	Ø 50	40 cm	12	606.70
4016.TA050K.050.1	16683	Ø 50	50 cm	12	703.40
4016.TA050K.060.1	16704	Ø 50	60 cm	12	780.00
4016.TA050K.080.1	16722	Ø 50	80 cm	12	943.40

Duş kanalı / W200-330-400-500-600 mm / Ø 50 yan - alt çıkış
Plastik gövde / Paslanmaz ızgara ve çerçeve / Sulu koku tutucu

Detaylar

DN 50 Yan ve Alt çıkış – Pvc boru bağlantılarına uyumludur. Akış hızı 32 lt/dk'dır. Izgarası 304 kalite paslanmaz çeliktir.

Avantajlar

304 kalite paslanmaz çelik ızgarası sayesinde şık ve kaliteli bir görünüme sahiptir. Duvar dibi uygulamalarda rahatlıkla uygulanabilir. Su tutuculu koku önleyici sayesinde tesisattan gelecek kötü kokuları önler. Yükseltme ayakları sayesinde şapın yüksekliğine göre ayarlama olanağı sağlar. Organik ve inorganik kimyasallara yüksek dayanım. çoğu asidik ve tuzlu su oksidasyonuna dayanıklıdır.

Kullanım Alanları

Genel kullanım banyo duşları. hastane ve otel duş alanları. soyunma odaları duş alanları vb.

Özel Üretim

Izgara modeli olarak isteğinize göre altın, bronz gibi renkler de üretilmektedir.

Uyarı

Yüksek yoğunluklu temizlik malzemelerinin uzun süreli kullanımı tavsiye edilmez.

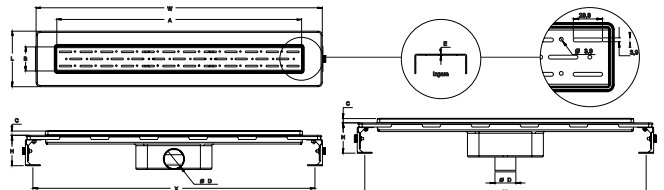

LINE

Ürün Kodu	Kısa Kod	Çıkış	Ölçü		Fiyat
YAN ÇIKIŞ					
4023.0Y050K.033.1	16648	Ø 50	33 cm	12	336.70
4023.0Y050K.040.1	16669	Ø 50	40 cm	12	363.40
4023.0Y050K.050.1	16689	Ø 50	50 cm	12	420.00
4023.0Y050K.060.1	16705	Ø 50	60 cm	12	466.70
4023.0Y050K.080.1	18687	Ø 50	80 cm	12	576.70
ALT ÇIKIŞ					
4023.0A050K.033.1	16723	Ø 50	33 cm	12	336.70
4023.0A050K.040.1	16742	Ø 50	40 cm	12	363.40
4023.0A050K.050.1	16755	Ø 50	50 cm	12	420.00
4023.0A050K.060.1	16769	Ø 50	60 cm	12	466.70
4023.0A050K.080.1	18720	Ø 50	80 cm	12	576.70

Duş kanalı / W200-330-400-500-600-800 mm / Ø 50 yan - alt çıkış
Plastik gövde / Paslanmaz ızgara / Sulu koku tutucu

LINE T.M.

Ürün Kodu	Kısa Kod	Çıkış	Ölçü		Fiyat
YAN ÇIKIŞ					
4023.TY050K.033.1	16739	Ø 50	33 cm	12	426.70
4023.TY050K.040.1	16768	Ø 50	40 cm	12	463.40
4023.TY050K.050.1	16783	Ø 50	50 cm	12	533.40
4023.TY050K.060.1	16800	Ø 50	60 cm	12	593.40
4023.TY050K.080.1	18739	Ø 50	80 cm	12	723.40
ALT ÇIKIŞ					
4023.TA050K.033.1	16791	Ø 50	33 cm	12	426.70
4023.TA050K.040.1	16805	Ø 50	40 cm	12	463.40
4023.TA050K.050.1	16818	Ø 50	50 cm	12	533.40
4023.TA050K.060.1	16832	Ø 50	60 cm	12	593.40
4023.TA050K.080.1	18763	Ø 50	80 cm	12	723.40

Duş kanalı / W200-330-400-500-600-800 mm / Ø 50 yan - alt çıkış
Plastik gövde / Paslanmaz ızgara / Sulu koku tutucu

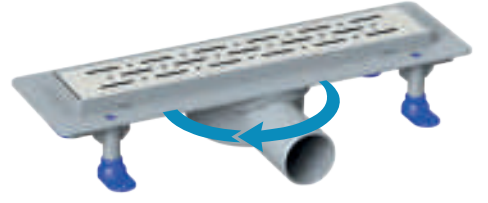

HM-31360

Prime koku tutucu kullanılmaktadır.



HM-31360

Prime koku tutucu kullanılmaktadır.



LINE Y360°



HM-31360

Prime koku tutucu kullanılmaktadır.

Ürün Kodu	Kısa Kod	Çıkış	Ölçü	Fiyat
YAN ÇIKIŞ				
4020.0Y050K.033.1	30257	Ø 50	33 cm	12
4020.0Y050K.040.1	30261	Ø 50	40 cm	12
4020.0Y050K.050.1	30265	Ø 50	50 cm	12
4020.0Y050K.060.1	30269	Ø 50	60 cm	12
4020.0Y050K.080.1	30273	Ø 50	80 cm	12
ALT ÇIKIŞ				
4020.0A050K.033.1	30277	Ø 50	33 cm	12
4020.0A050K.040.1	30281	Ø 50	40 cm	12
4020.0A050K.050.1	30285	Ø 50	50 cm	12
4020.0A050K.060.1	30289	Ø 50	60 cm	12
4020.0A050K.080.1	30293	Ø 50	80 cm	12

Duş kanalı / W200-330-400-500-600-800 mm / Ø 50 yan - alt çıkış
Plastik gövde / Paslanmaz ızgara / Sulu koku tutucu

LINE T.M. Y360°



HM-31360

Prime koku tutucu kullanılmaktadır.

Ürün Kodu	Kısa Kod	Çıkış	Ölçü	Fiyat
YAN ÇIKIŞ				
4020.TY050K.033.1	30297	Ø 50	33 cm	12
4020.TY050K.040.1	30301	Ø 50	40 cm	12
4020.TY050K.050.1	30305	Ø 50	50 cm	12
4020.TY050K.060.1	30309	Ø 50	60 cm	12
4020.TY050K.080.1	30313	Ø 50	80 cm	12
ALT ÇIKIŞ				
4020.TA050K.033.1	30317	Ø 50	33 cm	12
4020.TA050K.040.1	30321	Ø 50	40 cm	12
4020.TA050K.050.1	30325	Ø 50	50 cm	12
4020.TA050K.060.1	30329	Ø 50	60 cm	12
4020.TA050K.080.1	30333	Ø 50	80 cm	12

Duş kanalı / W200-330-400-500-600-800 mm / Ø 50 yan - alt çıkış
Plastik gövde / Paslanmaz ızgara / Sulu koku tutucu

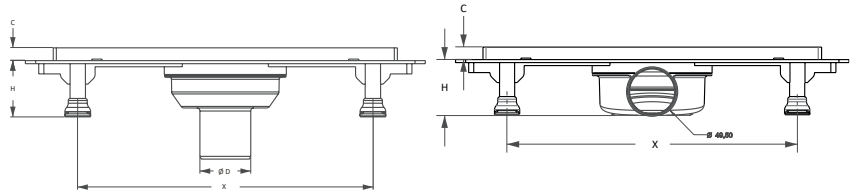
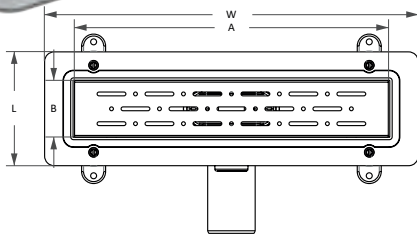

	W	L	H	ØD	A	B	C	X	E
4023.0Y050K.033.1	389	119	55	50	335	64.5	12.5	287	1
4023.0Y050K.040.1	454	119	55	50	405	64.5	12.5	387	1
4023.0Y050K.050.1	554	119	55	50	505	64.5	12.5	487	1
4023.0Y050K.060.1	654	119	55	50	605	64.5	12.5	587	1
4023.0Y050K.080.1	854	119	55	50	805	64.5	12.5	787	1

	W	L	H	ØD	A	B	C	X	E
4023.0A050K.033.1	389	119	55	50	335	64.5	12.5	287	1
4023.0A050K.040.1	454	119	55	50	405	64.5	12.5	387	1
4023.0A050K.050.1	554	119	55	50	505	64.5	12.5	487	1
4023.0A050K.060.1	654	119	55	50	605	64.5	12.5	587	1
4023.0A050K.080.1	854	119	55	50	805	64.5	12.5	787	1

Tablo ölçü birimi "mm"dir.

Detaylar

DN 50 Yan ve Alt çıkış – Pvc boru bağlantılarına uyumludur. Akış hızı 32 lt/dk'dır. Iızgarası 304 kalite paslanmaz çeliktir.

Avantajlar

304 kalite paslanmaz çelik ızgarası sayesinde şık ve kaliteli bir görünüme sahiptir. Duvar dibi uygulamalarda rahatlıkla uygulanabilir. Su tutuculu koku önleyici sayesinde tesisattan gelecek kötü kokuları önler. Yükseltme ayakları sayesinde şapın yüksekliğine göre ayarlama olanağı sağlar. Organik ve inorganik kimyasallara yüksek dayanım. çoğu asidik ve tuzlu su oksidasyonuna dayanıklıdır.

Kullanım Alanları

Genel kullanım banyo duşları, hastane ve otel duş alanları, soyunma odaları duş alanları vb.

Özel Üretim

Iızgara modeli olarak isteğinize göre altın, bronz gibi renkler de üretilmektedir.

Uyarı

Yüksek yoğunluklu temizlik malzemelerinin uzun süreli kullanımı tavsiye edilmez.

LEGAL

Ürün Kodu	Kısa Kod	Çıkış	Ölçü		Fiyat
YAN ÇIKIŞ					
4024.0Y050K.033.1	16842	Ø 50	33 cm	12	433.40
4024.0Y050K.040.1	16857	Ø 50	40 cm	12	473.40
4024.0Y050K.050.1	16880	Ø 50	50 cm	12	553.40
4024.0Y050K.060.1	16902	Ø 50	60 cm	12	620.00
4024.0Y050K.080.1	18723	Ø 50	80 cm	12	766.70
ALT ÇIKIŞ					
4024.0A050K.033.1	16841	Ø 50	33 cm	12	433.40
4024.0A050K.040.1	16860	Ø 50	40 cm	12	473.40
4024.0A050K.050.1	16876	Ø 50	50 cm	12	553.40
4024.0A050K.060.1	16892	Ø 50	60 cm	12	620.00
4024.0A050K.080.1	18740	Ø 50	80 cm	12	766.70

Duş kanalı / W200-330-400-500-600-800 mm / Ø 50 yan - alt çıkış
Plastik gövde / Paslanmaz çerçeve ve ızgara / Sulu koku tutucu



HM-31360
Prime koku tutucu kullanılmaktadır.

LEGAL T.M.

Ürün Kodu	Kısa Kod	Çıkış	Ölçü		Fiyat
YAN ÇIKIŞ					
4024.TY050K.033.1	16922	Ø 50	33 cm	12	500.00
4024.TY050K.040.1	16940	Ø 50	40 cm	12	546.70
4024.TY050K.050.1	16951	Ø 50	50 cm	12	636.70
4024.TY050K.060.1	16968	Ø 50	60 cm	12	710.00
4024.TY050K.080.1	18754	Ø 50	80 cm	12	870.00
ALT ÇIKIŞ					
4024.TA050K.033.1	16915	Ø 50	33 cm	12	500.00
4024.TA050K.040.1	16941	Ø 50	40 cm	12	546.70
4024.TA050K.050.1	16967	Ø 50	50 cm	12	636.70
4024.TA050K.060.1	16986	Ø 50	60 cm	12	710.00
4024.TA050K.080.1	18770	Ø 50	80 cm	12	870.00

Duş kanalı / W200-330-400-500-600-800 mm / Ø 50 yan - alt çıkış
Plastik gövde / Paslanmaz çerçeve ve ızgara / Sulu koku tutucu



HM-31360
Prime koku tutucu kullanılmaktadır.

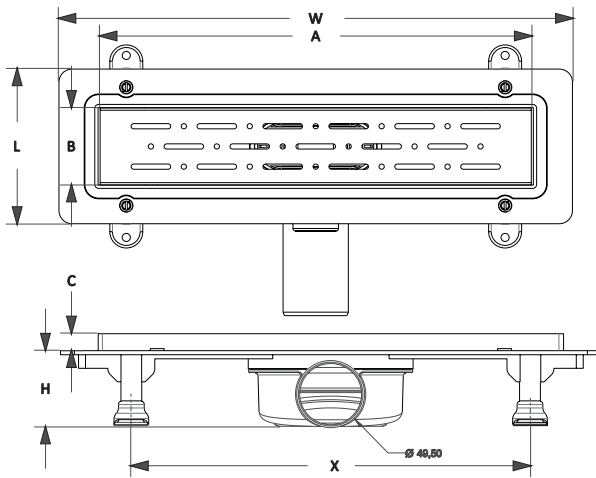

	W	L	H	Ø D	A	B	C	X	E
4024.0A050K.033.1	389	119	55	50	335	64.5	12.5	287	1
4024.0A050K.040.1	454	119	55	50	405	64.5	12.5	387	1
4024.0A050K.050.1	554	119	55	50	505	64.5	12.5	487	1
4024.0A050K.060.1	654	119	55	50	605	64.5	12.5	587	1

Tablo ölçü birimi "mm"dir.

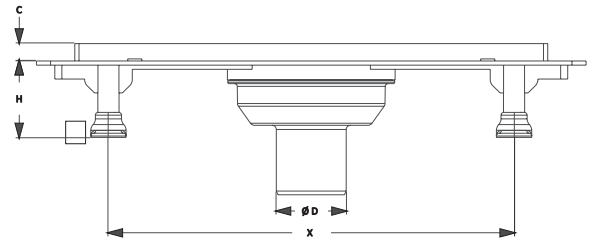

	W	L	H	Ø D	A	B	C	X	E
4024.0Y050K.033.1	389	119	55	50	335	64.5	12.5	287	1
4024.0Y050K.040.1	454	119	55	50	405	64.5	12.5	387	1
4024.0Y050K.050.1	554	119	55	50	505	64.5	12.5	487	1
4024.0Y050K.060.1	654	119	55	50	605	64.5	12.5	587	1



HM-31360

Prime koku tutucu kullanılmaktadır.

LEGAL Y360°

Ürün Kodu	Kısa Kod	Çıkış	Ölçü	Fiyat
YAN ÇIKIŞ				
4021.0Y050K.033.1	30337	Ø 50	33 cm	12
4021.0Y050K.040.1	30341	Ø 50	40 cm	12
4021.0Y050K.050.1	30345	Ø 50	50 cm	12
4021.0Y050K.060.1	30349	Ø 50	60 cm	12
4021.0Y050K.080.1	30353	Ø 50	80 cm	12
ALT ÇIKIŞ				
4021.0A050K.033.1	30357	Ø 50	33 cm	12
4021.0A050K.040.1	30361	Ø 50	40 cm	12
4021.0A050K.050.1	30365	Ø 50	50 cm	12
4021.0A050K.060.1	30369	Ø 50	60 cm	12
4021.0A050K.080.1	30373	Ø 50	80 cm	12

Duş kanalı / W200-330-400-500-600-800 mm / Ø 50 yan - alt çıkış
Plastik gövde / Paslanmaz çerçeve ve ızgara / Sulu koku tutucu

LEGAL T.M. Y360°

Ürün Kodu	Kısa Kod	Çıkış	Ölçü	Fiyat
YAN ÇIKIŞ				
4021.TY050K.033.1	30377	Ø 50	33 cm	12
4021.TY050K.040.1	30381	Ø 50	40 cm	12
4021.TY050K.050.1	30385	Ø 50	50 cm	12
4021.TY050K.060.1	30389	Ø 50	60 cm	12
4021.TY050K.080.1	30393	Ø 50	80 cm	12
ALT ÇIKIŞ				
4021.TA050K.033.1	30397	Ø 50	33 cm	12
4021.TA050K.040.1	30401	Ø 50	40 cm	12
4021.TA050K.050.1	30405	Ø 50	50 cm	12
4021.TA050K.060.1	30409	Ø 50	60 cm	12
4021.TA050K.080.1	30413	Ø 50	80 cm	12

Duş kanalı / W200-330-400-500-600-800 mm / Ø 50 yan - alt çıkış
Plastik gövde / Paslanmaz çerçeve ve ızgara / Sulu koku tutucu



HM-31360

Prime koku tutucu kullanılmaktadır.

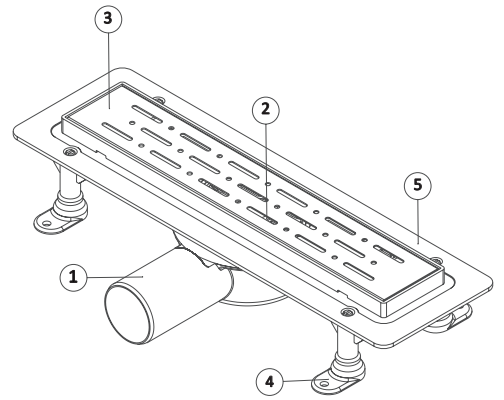

PARÇA NO	PARÇA AÇIKLAMASI	MALZEME	ADET
4023.1	Plastik Alt Gövde	ABS	1
4023.2	Koku Tutucu	ABS	1
4023.3	Paslanmaz Izgara	AISI 304	1
4023.4	Yükseklik Ayarlı Montaj Seti	PP	4
4023.5	Plastik Üst Gövde	PP	1



RAIN

KARE

BAHN

DOLU

DELUXE

Ürün Kodu	Kısa Kod	Çıkış	Ölçü		Fiyat
YAN ÇIKIŞ					
4025.0Y050K.033.1	16978	Ø 50	33 cm	12	513.40
4025.0Y050K.040.1	17003	Ø 50	40 cm	12	570.00
4025.0Y050K.050.1	17031	Ø 50	50 cm	12	663.40
4025.0Y050K.060.1	17041	Ø 50	60 cm	12	756.70
4025.0Y050K.080.1	18784	Ø 50	80 cm	12	936.70
ALT ÇIKIŞ					
4025.0A050K.033.1	17004	Ø 50	33 cm	12	513.40
4025.0A050K.040.1	17018	Ø 50	40 cm	12	570.00
4025.0A050K.050.1	17030	Ø 50	50 cm	12	663.40
4025.0A050K.060.1	17071	Ø 50	60 cm	12	756.70
4025.0A050K.080.1	18795	Ø 50	80 cm	12	936.70

Duş kanalı / W200-330-400-500-600-800 mm / Ø 50 yan - alt çıkış
Plastik gövde / Paslanmaz çerçeve ve ızgara / Sulu koku tutucu



HM-31360

Prime koku tutucu kullanılmaktadır.

DELUXE T.M.

Ürün Kodu	Kısa Kod	Çıkış	Ölçü		Fiyat
YAN ÇIKIŞ					
4025.TY050K.033.1	17050	Ø 50	33 cm	12	570.00
4025.TY050K.040.1	17059	Ø 50	40 cm	12	633.40
4025.TY050K.050.1	17081	Ø 50	50 cm	12	733.40
4025.TY050K.060.1	17098	Ø 50	60 cm	12	833.40
4025.TY050K.080.1	18792	Ø 50	80 cm	12	1023.40
ALT ÇIKIŞ					
4025.TA050K.033.1	17085	Ø 50	33 cm	12	570.00
4025.TA050K.040.1	17130	Ø 50	40 cm	12	633.40
4025.TA050K.050.1	17145	Ø 50	50 cm	12	733.40
4025.TA050K.060.1	17160	Ø 50	60 cm	12	833.40
4025.TA050K.080.1	18815	Ø 50	80 cm	12	1023.40

Duş kanalı / W200-330-400-500-600-800 mm / Ø 50 yan - alt çıkış
Plastik gövde / Paslanmaz çerçeve ve ızgara / Sulu koku tutucu

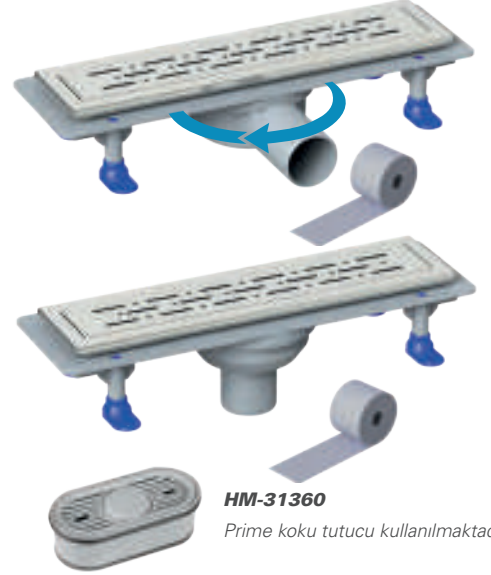

HM-31360

Prime koku tutucu kullanılmaktadır.



DELUXE Y360°



HM-31360

Prime koku tutucu kullanılmaktadır.

Ürün Kodu	Kısa Kod	Çıkış	Ölçü		Fiyat
YAN ÇIKIŞ					
4029.0Y050K.033.1	30417	Ø 50	33 cm	12	560.00
4029.0Y050K.040.1	30421	Ø 50	40 cm	12	613.40
4029.0Y050K.050.1	30425	Ø 50	50 cm	12	700.00
4029.0Y050K.060.1	30429	Ø 50	60 cm	12	786.70
4029.0Y050K.080.1	30433	Ø 50	80 cm	12	960.00
ALT ÇIKIŞ					
4029.0A050K.033.1	30437	Ø 50	33 cm	12	560.00
4029.0A050K.040.1	30441	Ø 50	40 cm	12	613.40
4029.0A050K.050.1	30445	Ø 50	50 cm	12	700.00
4029.0A050K.060.1	30449	Ø 50	60 cm	12	786.70
4029.0A050K.080.1	30453	Ø 50	80 cm	12	960.00

Duş kanalı / W200-330-400-500-600-800 mm / Ø 50 yan - alt çıkış
Plastik gövde / Paslanmaz çerçeve ve ızgara / Sulu koku tutucu

DELUXE T.M. Y360°



HM-31360

Prime koku tutucu kullanılmaktadır.

Ürün Kodu	Kısa Kod	Çıkış	Ölçü		Fiyat
YAN ÇIKIŞ					
4029.TY050K.033.1	30457	Ø 50	33 cm	12	616.70
4029.TY050K.040.1	30461	Ø 50	40 cm	12	673.40
4029.TY050K.050.1	30465	Ø 50	50 cm	12	773.40
4029.TY050K.060.1	30469	Ø 50	60 cm	12	866.70
4029.TY050K.080.1	30473	Ø 50	80 cm	12	1046.70
ALT ÇIKIŞ					
4029.TA050K.033.1	30477	Ø 50	33 cm	12	616.70
4029.TA050K.040.1	30481	Ø 50	40 cm	12	673.40
4029.TA050K.050.1	30485	Ø 50	50 cm	12	773.40
4029.TA050K.060.1	30489	Ø 50	60 cm	12	866.70
4029.TA050K.080.1	30493	Ø 50	80 cm	12	1046.70

Duş kanalı / W200-330-400-500-600-800 mm / Ø 50 yan - alt çıkış
Plastik gövde / Paslanmaz çerçeve ve ızgara / Sulu koku tutucu

Detaylar

DN 50 Yan ve Alt çıkış – Pvc boru bağlantılarına uyumlu. sulu tip (36mm) koku önleyiciye sahiptir. Akış hızı 32 lt/dk'dır. Dış kimyasal etkilere dayanım çalışma sıcaklığı -30°+75° arasındır. Izgarası 304 kalite paslanmaz çeliktir.

Avantajlar

304 kalite paslanmaz çelik ızgarası sayesinde şık ve kaliteli bir görünüme sahiptir. Duvar dibi uygulamalarda rahatlıkla uygulanabilir. Su tutuculu koku önleyici sayesinde tesisattan gelecek kötü kokuları önler. Yükseltme ayakları sayesinde şapın yüksekliğine göre ayarlama olanakları sağlar. Organik ve inorganik kimyasallara yüksek dayanım, çoğu asidik ve tuzlu su oksidasyonuna dayanıklıdır.

Kullanım Alanları

Genel kullanım banyo duşları, hastane ve otel duş alanları, soyunma odaları duş alanları vb.

Özel Üretim

Izgara modeli olarak istegınıza göre altın, bronz gibi renkler de üretilmektedir.

Uyarı

Yüksek yoğunluklu temizlik malzemelerinin uzun süreli kullanımı tavsiye edilmez.

	W	L	H	ØD	A	B	C	X	E
4028.0Y050K.033.1	389	119	55	50	335	64.5	12.5	287	1
4028.0Y050K.040.1	454	119	55	50	405	64.5	12.5	387	1
4028.0Y050K.050.1	554	119	55	50	505	64.5	12.5	487	1
4028.0Y050K.060.1	654	119	55	50	605	64.5	12.5	587	1

	W	L	H	ØD	A	B	C	X	E
4028.0A050K.033.1	389	119	55	50	335	64.5	12.5	287	1
4028.0A050K.040.1	454	119	55	50	405	64.5	12.5	387	1
4028.0A050K.050.1	554	119	55	50	505	64.5	12.5	487	1
4028.0A050K.060.1	654	119	55	50	605	64.5	12.5	587	1

Tablo ölçü birimi "mm"dir.

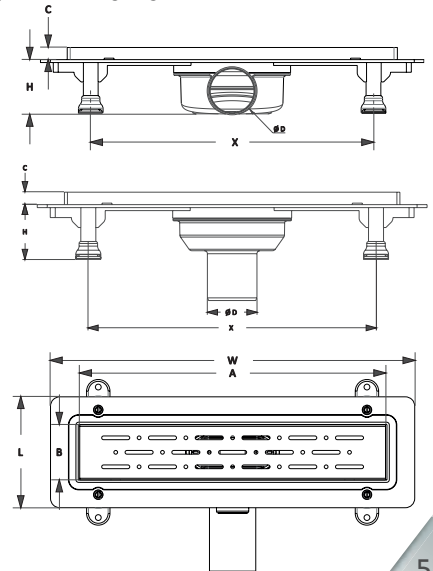

SCALA

Ürün Kodu	Kısa Kod	Çıkış	Ölçü		Fiyat
YAN ÇIKIŞ					
4026.0Y050K.033.1	17107	Ø 50	33 cm	12	330.00
4026.0Y050K.040.1	17108	Ø 50	40 cm	12	360.00
4026.0Y050K.050.1	17109	Ø 50	50 cm	12	420.00
4026.0Y050K.060.1	17110	Ø 50	60 cm	12	480.00
4026.0Y050K.080.1	18806	Ø 50	80 cm	12	570.00
ALT ÇIKIŞ					
4026.0A050K.033.1	17111	Ø 50	33 cm	12	330.00
4026.0A050K.040.1	17112	Ø 50	40 cm	12	360.00
4026.0A050K.050.1	17113	Ø 50	50 cm	12	420.00
4026.0A050K.060.1	17114	Ø 50	60 cm	12	480.00
4026.0A050K.080.1	18810	Ø 50	80 cm	12	570.00

Duș kanalı / W200-330-400-500-600-800 mm / Ø 50 yan - alt çıkış
Plastik gövde / Paslanmaz ızgara / Sulu koku tutucu



HM-31360

Prime koku tutucu kullanılmaktadır.

SCALA T.M.

Ürün Kodu	Kısa Kod	Çıkış	Ölçü		Fiyat
YAN ÇIKIŞ					
4026.TY050K.033.1	17115	Ø 50	33 cm	12	386.70
4026.TY050K.040.1	17116	Ø 50	40 cm	12	426.70
4026.TY050K.050.1	17117	Ø 50	50 cm	12	493.40
4026.TY050K.060.1	17118	Ø 50	60 cm	12	563.40
4026.TY050K.080.1	18813	Ø 50	80 cm	12	660.00
ALT ÇIKIŞ					
4026.TA050K.033.1	17119	Ø 50	33 cm	12	386.70
4026.TA050K.040.1	17120	Ø 50	40 cm	12	426.70
4026.TA050K.050.1	17121	Ø 50	50 cm	12	493.40
4026.TA050K.060.1	17122	Ø 50	60 cm	12	563.40
4026.TA050K.080.1	18816	Ø 50	80 cm	12	660.00

Duș kanalı / W200-330-400-500-600-800 mm / Ø 50 yan - alt çıkış
Plastik gövde / Paslanmaz ızgara / Sulu koku tutucu



HM-31360

Prime koku tutucu kullanılmaktadır.

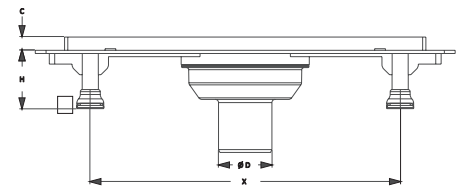
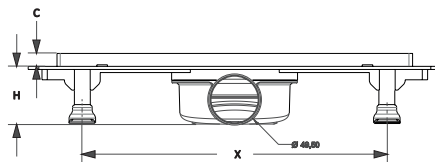
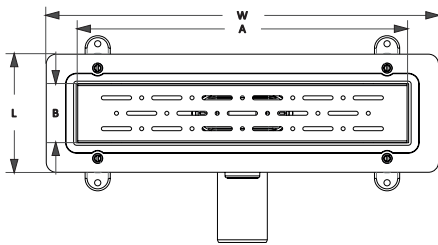

	W	L	H	Ø D	A	B	C	X	E
4024.0Y050K.033.1	389	119	55	50	335	64.5	12.5	287	1
4024.0Y050K.040.1	454	119	55	50	405	64.5	12.5	387	1
4024.0Y050K.050.1	554	119	55	50	505	64.5	12.5	487	1
4024.0Y050K.060.1	654	119	55	50	605	64.5	12.5	587	1

	W	L	H	Ø D	A	B	C	X	E
4024.0A050K.033.1	389	119	55	50	335	64.5	12.5	287	1
4024.0A050K.040.1	454	119	55	50	405	64.5	12.5	387	1
4024.0A050K.050.1	554	119	55	50	505	64.5	12.5	487	1
4024.0A050K.060.1	654	119	55	50	605	64.5	12.5	587	1

Tablo ölçü birimi "mm"dir.



RAİN



KARE



BAHN

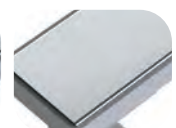

DOLU

SCALA Y360°



HM-31360

Prime koku tutucu kullanılmaktadır.

Ürün Kodu	Kısa Kod	Çıkış	Ölçü		Fiyat
YAN ÇIKIŞ					
4030.0Y050K.033.1	30497	Ø 50	33 cm	12	373.40
4030.0Y050K.040.1	30501	Ø 50	40 cm	12	403.40
4030.0Y050K.050.1	30505	Ø 50	50 cm	12	460.00
4030.0Y050K.060.1	30509	Ø 50	60 cm	12	520.00
4030.0Y050K.080.1	30513	Ø 50	80 cm	12	603.40
ALT ÇIKIŞ					
4030.0A050K.033.1	30517	Ø 50	33 cm	12	373.40
4030.0A050K.040.1	30521	Ø 50	40 cm	12	403.40
4030.0A050K.050.1	30525	Ø 50	50 cm	12	460.00
4030.0A050K.060.1	30529	Ø 50	60 cm	12	520.00
4030.0A050K.080.1	30533	Ø 50	80 cm	12	603.40

Duş kanalı / W200-330-400-500-600-800 mm / Ø 50 yan - alt çıkış
Plastik gövde / Paslanmaz ızgara / Sulu koku tutucu

SCALA T.M. Y360°



HM-31360

Prime koku tutucu kullanılmaktadır.

Ürün Kodu	Kısa Kod	Çıkış	Ölçü		Fiyat
YAN ÇIKIŞ					
4030.TY050K.033.1	30537	Ø 50	33 cm	12	433.40
4030.TY050K.040.1	30541	Ø 50	40 cm	12	470.00
4030.TY050K.050.1	30545	Ø 50	50 cm	12	533.40
4030.TY050K.060.1	30549	Ø 50	60 cm	12	600.00
4030.TY050K.080.1	30553	Ø 50	80 cm	12	693.40
ALT ÇIKIŞ					
4030.TA050K.033.1	30557	Ø 50	33 cm	12	433.40
4030.TA050K.040.1	30561	Ø 50	40 cm	12	470.00
4030.TA050K.050.1	30565	Ø 50	50 cm	12	533.40
4030.TA050K.060.1	30569	Ø 50	60 cm	12	600.00
4030.TA050K.080.1	30573	Ø 50	80 cm	12	693.40

Duş kanalı / W200-330-400-500-600-800 mm / Ø 50 yan - alt çıkış
Plastik gövde / Paslanmaz ızgara / Sulu koku tutucu



SCALA LEGAL

Ürün Kodu	Kısa Kod	Çıkış	Ölçü		Fiyat
YAN ÇIKIŞ					
4027.0Y050K.033.1	17128	Ø 50	33 cm	12	416.70
4027.0Y050K.040.1	17131	Ø 50	40 cm	12	463.40
4027.0Y050K.050.1	17133	Ø 50	50 cm	12	543.40
4027.0Y050K.060.1	17135	Ø 50	60 cm	12	623.40
4027.0Y050K.080.1	18818	Ø 50	80 cm	12	743.40
ALT ÇIKIŞ					
4027.0A050K.033.1	17138	Ø 50	33 cm	12	416.70
4027.0A050K.040.1	17141	Ø 50	40 cm	12	463.40
4027.0A050K.050.1	17143	Ø 50	50 cm	12	543.40
4027.0A050K.060.1	17146	Ø 50	60 cm	12	623.40
4027.0A050K.080.1	18822	Ø 50	80 cm	12	743.40

Duş kanalı / W200-330-400-500-600-800 mm / Ø 50 yan - alt çıkış
Plastik gövde / Paslanmaz çerçeve ve ızgara / Sulu koku tutucu



HM-31360

Prime koku tutucu kullanılmaktadır.

SCALA LEGAL T.M.

Ürün Kodu	Kısa Kod	Çıkış	Ölçü		Fiyat
YAN ÇIKIŞ					
4027.TY050K.033.1	17148	Ø 50	33 cm	12	460.00
4027.TY050K.040.1	17151	Ø 50	40 cm	12	510.00
4027.TY050K.050.1	17153	Ø 50	50 cm	12	596.70
4027.TY050K.060.1	17156	Ø 50	60 cm	12	683.40
4027.TY050K.080.1	18824	Ø 50	80 cm	12	806.70
ALT ÇIKIŞ					
4027.TA050K.033.1	17159	Ø 50	33 cm	12	460.00
4027.TA050K.040.1	17161	Ø 50	40 cm	12	510.00
4027.TA050K.050.1	17163	Ø 50	50 cm	12	596.70
4027.TA050K.060.1	17165	Ø 50	60 cm	12	683.40
4027.TA050K.080.1	18828	Ø 50	80 cm	12	806.70

Duş kanalı / W200-330-400-500-600-800 mm / Ø 50 yan - alt çıkış
Plastik gövde / Paslanmaz çerçeve ve ızgara / Sulu koku tutucu



HM-31360

Prime koku tutucu kullanılmaktadır.



SCALA LEGAL Y360°



HM-31360

Prime koku tutucu kullanılmaktadır.

Ürün Kodu	Kısa Kod	Çıkış	Ölçü	Fiyat
YAN ÇIKIŞ				
4031.0Y050K.033.1	30577	Ø 50	33 cm	12
4031.0Y050K.040.1	30581	Ø 50	40 cm	12
4031.0Y050K.050.1	30585	Ø 50	50 cm	12
4031.0Y050K.060.1	30589	Ø 50	60 cm	12
4031.0Y050K.080.1	30593	Ø 50	80 cm	12
ALT ÇIKIŞ				
4031.0A050K.033.1	30597	Ø 50	33 cm	12
4031.0A050K.040.1	30601	Ø 50	40 cm	12
4031.0A050K.050.1	30605	Ø 50	50 cm	12
4031.0A050K.060.1	30609	Ø 50	60 cm	12
4031.0A050K.080.1	30613	Ø 50	80 cm	12

Duş kanalı / W200-330-400-500-600-800 mm / Ø 50 yan - alt çıkış
Plastik gövde / Paslanmaz çerçeve ve ızgara / Sulu koku tutucu

SCALA LEGAL T.M. Y360°



HM-31360

Prime koku tutucu kullanılmaktadır.

Ürün Kodu	Kısa Kod	Çıkış	Ölçü	Fiyat
YAN ÇIKIŞ				
4031.TY050K.033.1	30617	Ø 50	33 cm	12
4031.TY050K.040.1	30621	Ø 50	40 cm	12
4031.TY050K.050.1	30625	Ø 50	50 cm	12
4031.TY050K.060.1	30629	Ø 50	60 cm	12
4031.TY050K.080.1	30633	Ø 50	80 cm	12
ALT ÇIKIŞ				
4031.TA050K.033.1	30637	Ø 50	33 cm	12
4031.TA050K.040.1	30641	Ø 50	40 cm	12
4031.TA050K.050.1	30645	Ø 50	50 cm	12
4031.TA050K.060.1	30649	Ø 50	60 cm	12
4031.TA050K.080.1	30653	Ø 50	80 cm	12

Duş kanalı / W200-330-400-500-600-800 mm / Ø 50 yan - alt çıkış
Plastik gövde / Paslanmaz çerçeve ve ızgara / Sulu koku tutucu

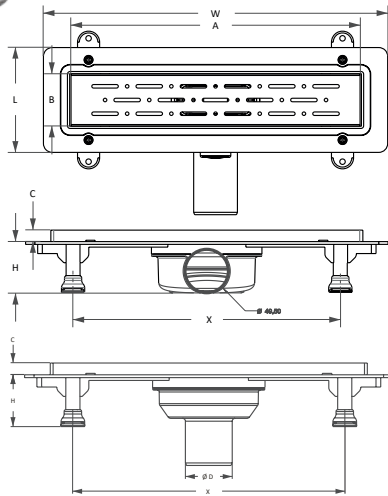

	W	L	H	Ø D	A	B	C	X	E
4023.0Y050K.033.1	389	119	55	50	335	64.5	12.5	287	1
4023.0Y050K.040.1	454	119	55	50	405	64.5	12.5	387	1
4023.0Y050K.050.1	554	119	55	50	505	64.5	12.5	487	1
4023.0Y050K.060.1	654	119	55	50	605	64.5	12.5	587	1
4023.0Y050K.080.1	854	119	55	50	805	64.5	12.5	787	1

Detaylar

DN 50 Yan ve Alt çıkış – Pvc boru bağlantılarına uyumludur. Akış hızı 32 lt/dk'dır. Iızgarası 304 kalite paslanmaz çeliklidir.

Avantajlar

304 kalite paslanmaz çelik ızgarası sayesinde şık ve kaliteli bir görünüme sahiptir. Duvar dibi uygulamalarda rahatlıkla uygulanabilir. Su tutuculu koku önleyici sayesinde tesisattan gelecek kötü kokuları önler. Yükseltme ayakları sayesinde şapın yüksekliğine göre ayarlama olanağı sağlar. Organik ve inorganik kimyasallara yüksek dayanım. çoğu asidik ve tuzlu su oksidasyonuna dayanıklıdır.

Kullanım Alanları

Genel kullanım banyo duşları, hastane ve otel duş alanları, soyunma odaları duş alanları vb.

Özel Üretim

Iızgara modeli olarak isteğinize göre altın, bronz gibi renkler de üretilmektedir.

Uyarı

Yüksek yoğunluklu temizlik malzemelerinin uzun süreli kullanımı tavsiye edilmez.

	W	L	H	Ø D	A	B	C	X	E
4023.0A050K.033.1	389	119	55	50	335	64.5	12.5	287	1
4023.0A050K.040.1	454	119	55	50	405	64.5	12.5	387	1
4023.0A050K.050.1	554	119	55	50	505	64.5	12.5	487	1
4023.0A050K.060.1	654	119	55	50	605	64.5	12.5	587	1
4023.0A050K.080.1	854	119	55	50	805	64.5	12.5	787	1

Tablo ölçü birimi "mm"dir.

SCALA DELUXE

Ürün Kodu	Kısa Kod	Çıkış	Ölçü		Fiyat
YAN ÇIKIŞ					
4028.0Y050K.033.1	17173	Ø 50	33 cm	12	500.00
4028.0Y050K.040.1	17176	Ø 50	40 cm	12	560.00
4028.0Y050K.050.1	17177	Ø 50	50 cm	12	653.40
4028.0Y050K.060.1	17178	Ø 50	60 cm	12	760.00
4028.0Y050K.080.1	18830	Ø 50	80 cm	12	913.40
ALT ÇIKIŞ					
4028.0A050K.033.1	17167	Ø 50	33 cm	12	500.00
4028.0A050K.040.1	17174	Ø 50	40 cm	12	560.00
4028.0A050K.050.1	17175	Ø 50	50 cm	12	653.40
4028.0A050K.060.1	17179	Ø 50	60 cm	12	760.00
4028.0A050K.080.1	18831	Ø 50	80 cm	12	913.40

Duş kanalı / W200-330-400-500-600-800 mm / Ø 50 yan - alt çıkış
Plastik gövde / Paslanmaz çerçeve ve ızgara / Sulu koku tutucu



HM-31360

Prime koku tutucu kullanılmaktadır.

SCALA DELUXE T.M.

Ürün Kodu	Kısa Kod	Çıkış	Ölçü		Fiyat
YAN ÇIKIŞ					
4028.TY050K.033.1	17181	Ø 50	33 cm	12	590.00
4028.TY050K.040.1	17182	Ø 50	40 cm	12	660.00
4028.TY050K.050.1	17183	Ø 50	50 cm	12	770.00
4028.TY050K.060.1	17184	Ø 50	60 cm	12	890.00
4028.TY050K.080.1	18832	Ø 50	80 cm	12	1063.40
ALT ÇIKIŞ					
4028.TA050K.033.1	17180	Ø 50	33 cm	12	590.00
4028.TA050K.040.1	17185	Ø 50	40 cm	12	660.00
4028.TA050K.050.1	17187	Ø 50	50 cm	12	770.00
4028.TA050K.060.1	17188	Ø 50	60 cm	12	890.00
4028.TA050K.080.1	18833	Ø 50	80 cm	12	1063.40

Duş kanalı / W200-330-400-500-600-800 mm / Ø 50 yan - alt çıkış
Plastik gövde / Paslanmaz çerçeve ve ızgara / Sulu koku tutucu



HM-31360

Prime koku tutucu kullanılmaktadır.

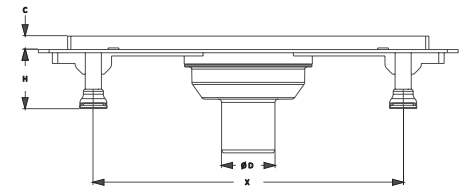
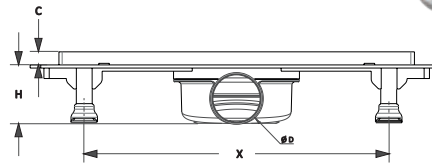
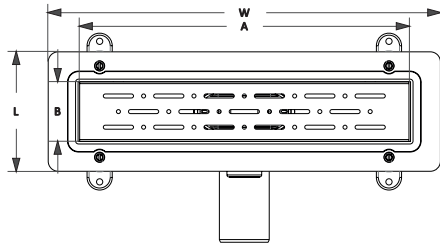

	W	L	H	Ø D	A	B	C	X	E
4028.0Y050K.033.1	389	119	55	50	335	64.5	12.5	287	1
4028.0Y050K.040.1	454	119	55	50	405	64.5	12.5	387	1
4028.0Y050K.050.1	554	119	55	50	505	64.5	12.5	487	1
4028.0Y050K.060.1	654	119	55	50	605	64.5	12.5	587	1

	W	L	H	Ø D	A	B	C	X	E
4028.0A050K.033.1	389	119	55	50	335	64.5	12.5	287	1
4028.0A050K.040.1	454	119	55	50	405	64.5	12.5	387	1
4028.0A050K.050.1	554	119	55	50	505	64.5	12.5	487	1
4028.0A050K.060.1	654	119	55	50	605	64.5	12.5	587	1

Tablo ölçü birimi "mm"dir.

Detaylar

DN 50 Yan ve Alt çıkış – Pvc boru bağlantılarına uyumludur. Akış hızı 32 lt/dk'dır. Izgarası 304 kalite paslanmaz çeliklidir.

Avantajlar

304 kalite paslanmaz çelik ızgarası sayesinde şık ve kaliteli bir görünüme sahiptir. Duvar dibi uygulamalarda rahatlıkla uygulanabilir. Su tutuculu koku önleyici sayesinde tesisattan gelecek kötü kokuları önler. Yükseltme ayakları sayesinde şapın yüksekliğine göre ayarlama olanağı sağlar. Organik ve inorganik kimyasallara yüksek dayanım. çoğu asidik ve tuzlu su oksidasyonuna dayanıklıdır.

Kullanım Alanları

Genel kullanım banyo duşları, hastane ve otel duş alanları, soyunma odaları duş alanları vb.

Özel Üretim

Izgara modeli olarak istediğimize göre altın, bronz gibi renkler de üretilmektedir.

Uyarı

Yüksek yoğunluklu temizlik malzemelerinin uzun süreli kullanımı tavsiye edilmez.

SCALA DELUXE Y360°



HM-31360

Prime koku tutucu kullanılmaktadır.

Ürün Kodu	Kısa Kod	Çıkış	Ölçü		Fiyat
YAN ÇIKIŞ					
4034.0Y050K.033.1	30657	Ø 50	33 cm	12	570.00
4034.0Y050K.040.1	30661	Ø 50	40 cm	12	633.40
4034.0Y050K.050.1	30665	Ø 50	50 cm	12	726.70
4034.0Y050K.060.1	30669	Ø 50	60 cm	12	833.40
4034.0Y050K.080.1	30673	Ø 50	80 cm	12	986.70
ALT ÇIKIŞ					
4034.0A050K.033.1	30677	Ø 50	33 cm	12	570.00
4034.0A050K.040.1	30681	Ø 50	40 cm	12	633.40
4034.0A050K.050.1	30685	Ø 50	50 cm	12	726.70
4034.0A050K.060.1	30689	Ø 50	60 cm	12	833.40
4034.0A050K.080.1	30693	Ø 50	80 cm	12	986.70

Duş kanalı / W200-330-400-500-600-800 mm / Ø 50 yan - alt çıkış
Plastik gövde / Paslanmaz çerçeve ve ızgara / Sulu koku tutucu

SCALA DELUXE T.M. Y360°



HM-31360

Prime koku tutucu kullanılmaktadır.

Ürün Kodu	Kısa Kod	Çıkış	Ölçü		Fiyat
YAN ÇIKIŞ					
4034.TY050K.033.1	30697	Ø 50	33 cm	12	636.70
4034.TY050K.040.1	30701	Ø 50	40 cm	12	703.40
4034.TY050K.050.1	30705	Ø 50	50 cm	12	806.70
4034.TY050K.060.1	30709	Ø 50	60 cm	12	923.40
4034.TY050K.080.1	30713	Ø 50	80 cm	12	1086.70
ALT ÇIKIŞ					
4034.TA050K.033.1	30717	Ø 50	33 cm	12	636.70
4034.TA050K.040.1	30721	Ø 50	40 cm	12	703.40
4034.TA050K.050.1	30725	Ø 50	50 cm	12	806.70
4034.TA050K.060.1	30729	Ø 50	60 cm	12	923.40
4034.TA050K.080.1	30733	Ø 50	80 cm	12	1086.70

Duş kanalı / W200-330-400-500-600-800 mm / Ø 50 yan - alt çıkış
Plastik gövde / Paslanmaz çerçeve ve ızgara / Sulu koku tutucu



LINE

Ürün Kodu	Kısa Kod	Çıkış	Ölçü		Fiyat
YAN ÇIKIŞ					
4033.0Y050K.033.1	17186	Ø 50	33 cm	12	546.70
4033.0Y050K.040.1	17203	Ø 50	40 cm	12	603.40
4033.0Y050K.050.1	17216	Ø 50	50 cm	12	750.00
4033.0Y050K.060.1	17236	Ø 50	60 cm	12	840.00
4033.0Y050K.080.1	17249	Ø 50	80 cm	12	990.00
ALT ÇIKIŞ					
4033.0A050K.033.1	17189	Ø 50	33 cm	12	546.70
4033.0A050K.040.1	17214	Ø 50	40 cm	12	603.40
4033.0A050K.050.1	17233	Ø 50	50 cm	12	750.00
4033.0A050K.060.1	17261	Ø 50	60 cm	12	840.00
4033.0A050K.080.1	17282	Ø 50	80 cm	12	990.00

Duş kanalı / W200-330-400-500-600 mm / Ø 50 yan - alt çıkış
Paslanmaz gövde / Paslanmaz ızgara / Sulu koku tutucu



HM-31361

Uzun koku tutucu kullanılmaktadır.

LINE T.M.

Ürün Kodu	Kısa Kod	Çıkış	Ölçü		Fiyat
YAN ÇIKIŞ					
4033.TY050K.033.1	17358	Ø 50	33 cm	12	603.40
4033.TY050K.040.1	17372	Ø 50	40 cm	12	690.00
4033.TY050K.050.1	17398	Ø 50	50 cm	12	843.40
4033.TY050K.060.1	17410	Ø 50	60 cm	12	923.40
4033.TY050K.080.1	17434	Ø 50	80 cm	12	1143.40
ALT ÇIKIŞ					
4033.TA050K.033.1	17385	Ø 50	33 cm	12	603.40
4033.TA050K.040.1	17411	Ø 50	40 cm	12	690.00
4033.TA050K.050.1	17426	Ø 50	50 cm	12	843.40
4033.TA050K.060.1	17444	Ø 50	60 cm	12	923.40
4033.TA050K.080.1	17467	Ø 50	80 cm	12	1143.40

Duş kanalı / W200-330-400-500-600 mm / Ø 50 yan - alt çıkış
Paslanmaz gövde / Paslanmaz ızgara / Sulu koku tutucu

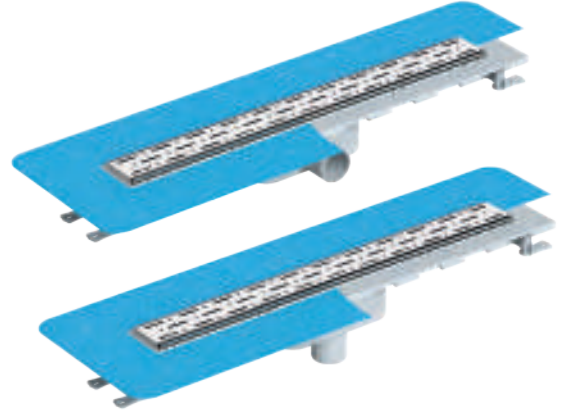

HM-31361

Uzun koku tutucu kullanılmaktadır.

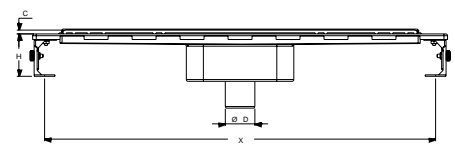
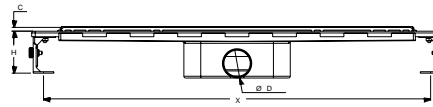

ÜRÜN KODU

ÜRÜN KODU	W	L	H	Ø D	A	B	C	X	E
4033.TY050K.033.1	423	134	72	49.5	330	54	8	385	1
4033.TY050K.040.1	492	134	72	49.5	400	54	8	456	1
4033.TY050K.050.1	592	134	72	49.5	500	54	8	556	1
4033.TY050K.060.1	693	134	72	49.5	600	54	8	656	1
4033.TY050K.080.1	893	134	72	49.5	800	54	8	856	1

ÜRÜN KODU

ÜRÜN KODU	W	L	H	Ø D	A	B	C	X	E
4033.TA050K.033.1	423	134	100	49.5	330	54	8	385	1
4033.TA050K.040.1	492	134	100	49.5	400	54	8	456	1
4033.TA050K.050.1	592	134	100	49.5	500	54	8	556	1
4033.TA050K.060.1	693	134	100	49.5	600	54	8	656	1
4033.TA050K.080.1	893	134	100	49.5	800	54	8	856	1

Tablo ölçü birimi "mm"dir.

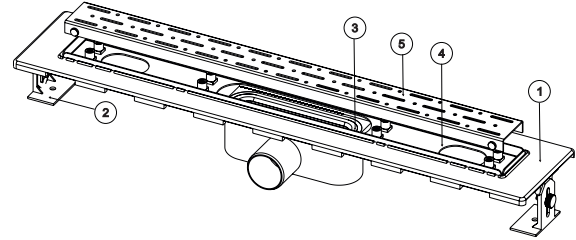

PARÇA NO	PARÇA AÇIKLAMASI	MALZEME	ADET
4033.1	Plastik Gövde Etekli	ABS	1
4033.2	Yükseklik Ayarlı Montaj Seti	PP	2
4033.3	Koku Tutucu	ABS	1
4033.4	Yük. Ayarlı Çerçeve	AISI 304	1
4033.5	Paslanmaz Iızgara	AISI 304	1





HM-31363

Legal koku tutucu kullanılmaktadır.

LEGAL

Ürün Kodu	Kısa Kod	Çıkış	Ölçü		Fiyat
YAN ÇIKIŞ					
4043.0Y050K.033.1	17524	Ø 50	33 cm	12	833.40
4043.0Y050K.040.1	17538	Ø 50	40 cm	12	930.00
4043.0Y050K.050.1	17557	Ø 50	50 cm	12	1136.70
4043.0Y050K.060.1	17575	Ø 50	60 cm	12	1286.70
4043.0Y050K.080.1	18834	Ø 50	80 cm	12	1550.00
ALT ÇIKIŞ					
4043.0A050K.033.1	17601	Ø 50	33 cm	12	833.40
4043.0A050K.040.1	17619	Ø 50	40 cm	12	930.00
4043.0A050K.050.1	17640	Ø 50	50 cm	12	1136.70
4043.0A050K.060.1	17661	Ø 50	60 cm	12	1286.70
4043.0A050K.080.1	18994	Ø 50	80 cm	12	1550.00

Duş kanalı / W200-330-400-500-600 mm / Ø 50 yan - alt çıkış
Paslanmaz gövde / Paslanmaz ızgara / Sulu koku tutucu

LEGAL T.M.

Ürün Kodu	Kısa Kod	Çıkış	Ölçü		Fiyat
YAN ÇIKIŞ					
4043.TY050K.033.1	17717	Ø 50	33 cm	12	900.00
4043.TY050K.040.1	17732	Ø 50	40 cm	12	1023.40
4043.TY050K.050.1	17750	Ø 50	50 cm	12	1236.70
4043.TY050K.060.1	17767	Ø 50	60 cm	12	1380.00
4043.TY050K.080.1	17783	Ø 50	80 cm	12	1663.40
ALT ÇIKIŞ					
4043.TA050K.033.1	17771	Ø 50	33 cm	12	900.00
4043.TA050K.040.1	17789	Ø 50	40 cm	12	1023.40
4043.TA050K.050.1	17801	Ø 50	50 cm	12	1236.70
4043.TA050K.060.1	17810	Ø 50	60 cm	12	1380.00
4043.TA050K.080.1	17823	Ø 50	80 cm	12	1663.40

Duş kanalı / W200-330-400-500-600 mm / Ø 50 yan - alt çıkış
Paslanmaz gövde / Paslanmaz ızgara / Sulu koku tutucu



HM-31363

Legal koku tutucu kullanılmaktadır.

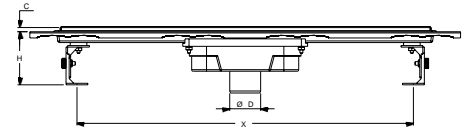
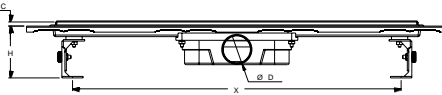
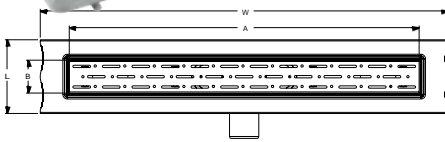

ÜRÜN KODU	W	L	H	ØD	A	B	C	X	E
4043.TY050K.033.1	423	134	85	49.5	330	54	8	385	1
4043.TY050K.040.1	492	134	85	49.5	400	54	8	456	1
4043.TY050K.050.1	592	134	85	49.5	500	54	8	556	1
4043.TY050K.060.1	693	134	85	49.5	600	54	8	656	1
4043.TY050K.080.1	893	134	85	49.5	800	54	8	856	1

PARÇA NO	PARÇA AÇIKLAMASI	MALZEME	ADET
4043.1	Plastik Alt Gövde	ABS	1
4043.2	Paslanmaz Üst Gövde	AISI 304	1
4043.3	Yükseklik Ayarlı Montaj Seti	PP	2
4043.4	Yükseklik Ayarlı Çerçeve	AISI 304	1
4043.5	Paslanmaz Izgara	AISI 304	1
4043.6	Koku Tutucu	ABS	1

ÜRÜN KODU	W	L	H	ØD	A	B	C	X	E
4043.TA050K.033.1	423	134	100	49.5	330	54	8	385	1
4043.TA050K.040.1	492	134	100	49.5	400	54	8	456	1
4043.TA050K.050.1	592	134	100	49.5	500	54	8	556	1
4043.TA050K.060.1	693	134	100	49.5	600	54	8	656	1
4043.TA050K.080.1	893	134	100	49.5	800	54	8	856	1

Tablo ölçü birimi "mm"dir.

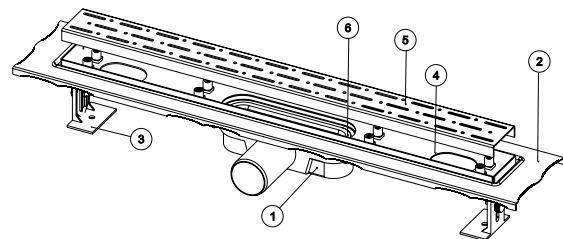

**HM-31363**

Legal koku tutucu kullanılmaktadır.

LEGAL Y360°

Ürün Kodu	Kısa Kod	Çıkış	Ölçü		Fiyat
YAN ÇIKIŞ					
4043.0Y360K.033.1	18012	Ø 50	33 cm	12	923.40
4043.0Y360K.040.1	18021	Ø 50	40 cm	12	1020.00
4043.0Y360K.050.1	18030	Ø 50	50 cm	12	1226.70
4043.0Y360K.060.1	18039	Ø 50	60 cm	12	1376.70
4043.0Y360K.080.1	18048	Ø 50	80 cm	12	1640.00
ALT ÇIKIŞ					
4043.0A360K.033.1	31395	Ø 50	33 cm	12	923.40
4043.0A360K.040.1	31396	Ø 50	40 cm	12	1020.00
4043.0A360K.050.1	31397	Ø 50	50 cm	12	1226.70
4043.0A360K.060.1	31398	Ø 50	60 cm	12	1376.70
4043.0A360K.080.1	31399	Ø 50	80 cm	12	1640.00

Duş kanalı / W200-330-400-500-600 mm / Ø 50 yan - alt çıkış
Paslanmaz gövde / Paslanmaz ızgara / Sulu koku tutucu

PREMIUM

Ürün Kodu	Kısa Kod	Çıkış	Ölçü		Fiyat
YAN ÇIKIŞ					
4045.0Y050K.033.9	18059	Ø 50	33 cm	12	1613.40
4045.0Y050K.045.9	18062	Ø 50	45 cm	12	1933.40
4045.0Y050K.060.9	18065	Ø 50	60 cm	12	2510.00
4045.0Y050K.080.9	18068	Ø 50	80 cm	12	3243.40
ALT ÇIKIŞ					
4045.0A050K.033.9	18070	Ø 50	33 cm	12	1613.40
4045.0A050K.045.9	18072	Ø 50	45 cm	12	1933.40
4045.0A050K.060.9	18074	Ø 50	60 cm	12	2510.00
4045.0A050K.080.9	18076	Ø 50	80 cm	12	3243.40

Duş kanalı / W200-330-400-500-600 mm / Ø 50 yan - alt çıkış
Paslanmaz gövde / Paslanmaz ızgara / Sulu koku tutucu

**HM-31363**

Legal koku tutucu kullanılmaktadır.

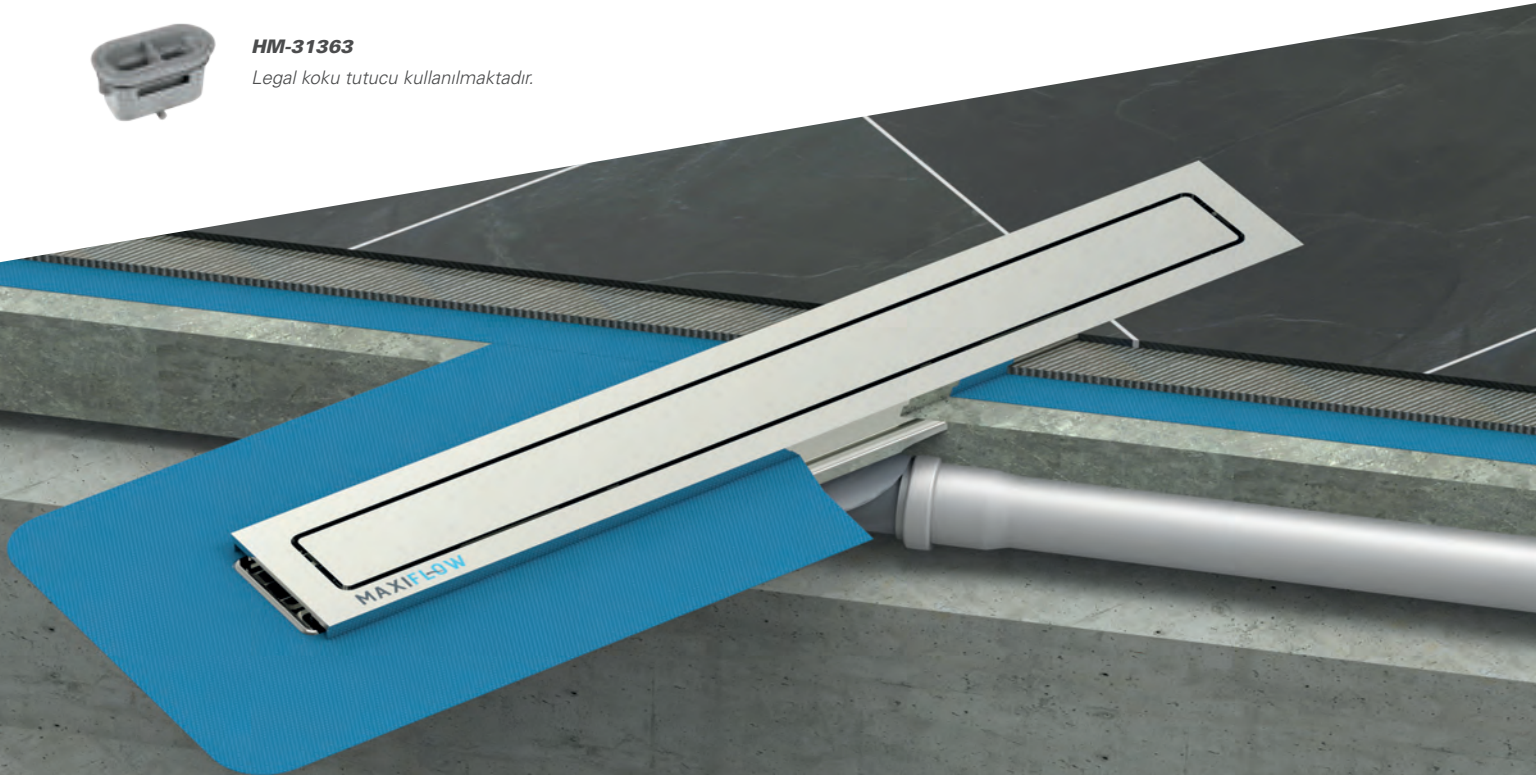

New



LUX LEGAL

Ürün Kodu	Kısa Kod	Çıkış	Ölçü		Fiyat
YAN ÇIKIŞ					
4050.0Y050K.020.1	-	Ø 50	20 cm	12	920.00
4050.0Y050K.033.1		Ø 50	33 cm	12	1073.40
4050.0Y050K.040.1		Ø 50	40 cm	12	1180.00
4050.0Y050K.050.1		Ø 50	50 cm	12	1336.70
4050.0Y050K.060.1		Ø 50	60 cm	12	1486.70
4050.0Y050K.080.1		Ø 50	80 cm	12	1783.40

Duş kanalı / W200-330-400-500-600-800 mm / Ø 50 yan
Paslanmaz gövde / Paslanmaz ızgara / Sulu koku tutucu



Legal koku tutucu kullanılmaktadır.

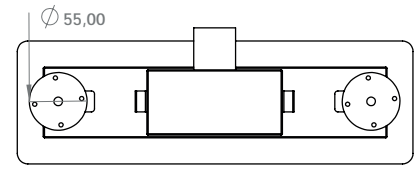
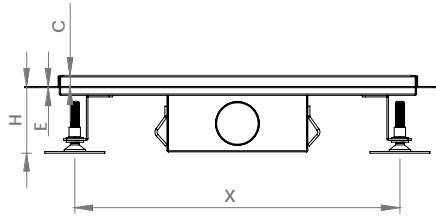
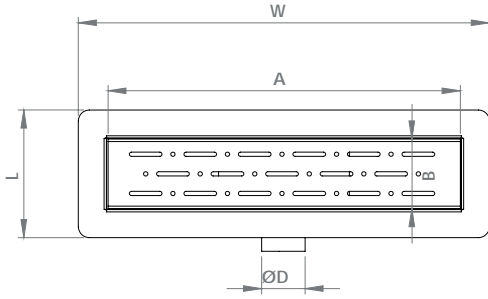

	W	L	H	Ø D	A	B	C	X	E
4050.0Y040K.020.1	246	117	60	40	196	64	10	221	1.5
4050.0Y040K.033.1	377	117	60	40	323	64	10	298	1.5
4050.0Y040K.040.1	446	117	60	40	392	64	10	417	1.5
4050.0Y040K.050.1	546	117	60	40	492	64	10	517	1.5
4050.0Y040K.060.1	646	117	60	40	592	64	10	617	1.5
4050.0Y040K.080.1	834	117	60	40	778	64	10	755	1.5



KLASİK LINE

Ürün Kodu	Kısa Kod	Çıkış	Ölçü		Fiyat
YAN ÇIKIŞ					
4012.SY050K.020.1	32409	Ø 50	20 cm	12	233.40
4012.SY050K.033.1	32410	Ø 50	33 cm	12	310.00
4012.SY050K.040.1	32411	Ø 50	40 cm	12	343.40
4012.SY050K.050.1	32412	Ø 50	50 cm	12	410.00
4012.SY050K.060.1	32413	Ø 50	60 cm	12	453.40
4012.SY050K.080.1	32414	Ø 50	80 cm	12	563.40
ALT ÇIKIŞ					
4012.SA050K.020.1	32415	Ø 50	20 cm	12	233.40
4012.SA050K.033.1	32416	Ø 50	33 cm	12	310.00
4012.SA050K.040.1	32417	Ø 50	40 cm	12	343.40
4012.SA050K.050.1	32418	Ø 50	50 cm	12	410.00
4012.SA050K.060.1	32419	Ø 50	60 cm	12	453.40
4012.SA050K.080.1	32420	Ø 50	80 cm	12	563.40

Duş kanalı / W200-330-400-500-600-800 mm / Ø 50 yan - alt çıkış
Plastik gövde / Paslanmaz ızgara / Sulu koku tutucu

KLASİK LEGAL

Ürün Kodu	Kısa Kod	Çıkış	Ölçü		Fiyat
YAN ÇIKIŞ					
4013.SY050K.020.1	32421	Ø 50	20 cm	12	390.00
4013.SY050K.033.1	32422	Ø 50	33 cm	12	566.70
4013.SY050K.040.1	32423	Ø 50	40 cm	12	626.70
4013.SY050K.050.1	32424	Ø 50	50 cm	12	740.00
4013.SY050K.060.1	32425	Ø 50	60 cm	12	830.00
4013.SY050K.080.1	32426	Ø 50	80 cm	12	996.70
ALT ÇIKIŞ					
4013.SA050K.020.1	32427	Ø 50	20 cm	12	390.00
4013.SA050K.033.1	32428	Ø 50	33 cm	12	566.70
4013.SA050K.040.1	32429	Ø 50	40 cm	12	626.70
4013.SA050K.050.1	32430	Ø 50	50 cm	12	740.00
4013.SA050K.060.1	32431	Ø 50	60 cm	12	830.00
4013.SA050K.080.1	32432	Ø 50	80 cm	12	996.70

Duş kanalı / W200-330-400-500-600-800 mm / Ø 50 yan - alt çıkış
Paslanmaz gövde / Paslanmaz ızgara / Sulu koku tutucu

PERA LINE

Ürün Kodu	Kısa Kod	Çıkış	Ölçü		Fiyat
YAN ÇIKIŞ					
3152.SY050K.033.1	32433	Ø 50	30 cm	12	273.40
3152.SY050K.040.1	32434	Ø 50	40 cm	12	306.70
3152.SY050K.050.1	32435	Ø 50	50 cm	12	366.70
3152.SY050K.060.1	32436	Ø 50	60 cm	12	400.00
3152.SY050K.080.1	32437	Ø 50	80 cm	12	463.40
ALT ÇIKIŞ					
3152.SA050K.033.1	32438	Ø 50	30 cm	12	273.40
3152.SA050K.040.1	32439	Ø 50	40 cm	12	306.70
3152.SA050K.050.1	32440	Ø 50	50 cm	12	366.70
3152.SA050K.060.1	32441	Ø 50	60 cm	12	400.00
3152.SA050K.080.1	32442	Ø 50	80 cm	12	463.40

Duş kanalı / W200-330-400-500-600-800 mm / Ø 50 yan - alt çıkış
Plastik gövde / Paslanmaz ızgara / Sulu koku tutucu



HM-31361

Uzun koku tutucu kullanılmaktadır.



HM-31361

Uzun koku tutucu kullanılmaktadır.



HM-27970

Pera koku tutucu kullanılmaktadır.

STYLE SIMPLE LINE

Ürün Kodu	Kısa Kod	Çıkış	Ölçü		Fiyat
ALT ÇIKIŞ					
4080.SA050K.033.1	32443	Ø 50	33 cm	12	220.00
4080.SA050K.040.1	32444	Ø 50	40 cm	12	266.70
4080.SA050K.050.1	32445	Ø 50	50 cm	12	330.00
4080.SA050K.060.1	32446	Ø 50	60 cm	12	366.70
4080.SA050K.080.1	32447	Ø 50	80 cm	12	433.40

Duş kanalı / W330-400-500-600-800 mm / Ø 50 yan - alt çıkış
Plastik gövde / Paslanmaz ızgara / Sulu koku tutucu



HM-31359
Style koku tutucu kullanılmaktadır.

STYLE SIMPLE LEGAL

Ürün Kodu	Kısa Kod	Çıkış	Ölçü		Fiyat
ALT ÇIKIŞ					
4086.SA050K.020.1	32448	Ø 50	20 cm	12	300.00
4086.SA050K.033.1	32449	Ø 50	33 cm	12	386.70
4086.SA050K.040.1	32450	Ø 50	40 cm	12	436.70
4086.SA050K.050.1	32451	Ø 50	50 cm	12	530.00
4086.SA050K.060.1	32452	Ø 50	60 cm	12	593.40
4086.SA050K.080.1	32453	Ø 50	80 cm	12	706.70

Duş kanalı / W200-330-400-500-600-800 mm / Ø 50 yan - alt çıkış
Paslanmaz gövde / Paslanmaz ızgara / Sulu koku tutucu



HM-31359
Style koku tutucu kullanılmaktadır.

STYLE SİMPLE VEGA

Ürün Kodu	Kısa Kod	Çıkış	Ölçü		Fiyat
ALT ÇIKIŞ					
4074.SA050K.040.1	32454	Ø 50	40 cm	12	443.40
4074.SA050K.050.1	32455	Ø 50	50 cm	12	513.40
4074.SA050K.060.1	32456	Ø 50	60 cm	12	580.00

Duş kanalı / W200-330-400-500-600-800 mm / Ø 50 yan - alt çıkış
Paslanmaz gövde / Paslanmaz ızgara / Sulu koku tutucu



HM-31359
Style koku tutucu kullanılmaktadır.

STYLE SİMPLE VEGA LUX

Ürün Kodu	Kısa Kod	Çıkış	Ölçü		Fiyat
ALT ÇIKIŞ					
4077.SA050K.040.1	32457	Ø 50	40 cm	12	516.70
4077.SA050K.050.1	32458	Ø 50	50 cm	12	610.00
4077.SA050K.060.1	32459	Ø 50	60 cm	12	670.00

Duş kanalı / W200-330-400-500-600-800 mm / Ø 50 yan - alt çıkış
Paslanmaz gövde / Paslanmaz çerçeve ve ızgara / Sulu koku tutucu



HM-31359
Style koku tutucu kullanılmaktadır.

STYLE SİMPLE ALFA

Ürün Kodu	Kısa Kod	Çıkış	Ölçü		Fiyat
ALT ÇIKIŞ					
4060.SA050K.020.1	32460	Ø 50	20 cm	12	353.40
4060.SA050K.030.1	32461	Ø 50	30 cm	12	443.40
4060.SA050K.040.1	32462	Ø 50	40 cm	12	520.00
4060.SA050K.050.1	32463	Ø 50	50 cm	12	633.40
4060.SA050K.060.1	32464	Ø 50	60 cm	12	710.00

Duş kanalı / W200-330-400-500-600-800 mm / Ø 50 yan - alt çıkış
Paslanmaz gövde / Paslanmaz ızgara / Sulu koku tutucu



HM-31359
Style koku tutucu kullanılmaktadır.

PERA LINE

Ürün Kodu	Kısa Kod	Çıkış	Ölçü		Fiyat
YAN ÇIKIŞ					
3155.SY050K.033.1	32465	Ø 50	30 cm	12	296.70
3155.SY050K.040.1	32466	Ø 50	40 cm	12	336.70
3155.SY050K.050.1	32467	Ø 50	50 cm	12	400.00
3155.SY050K.060.1	32468	Ø 50	60 cm	12	436.70
3155.SY050K.080.1	32469	Ø 50	80 cm	12	530.00
ALT ÇIKIŞ					
3155.SA050K.033.1	32470	Ø 50	30 cm	12	296.70
3155.SA050K.040.1	32471	Ø 50	40 cm	12	336.70
3155.SA050K.050.1	32472	Ø 50	50 cm	12	400.00
3155.SA050K.060.1	32473	Ø 50	60 cm	12	436.70
3155.SA050K.080.1	32474	Ø 50	80 cm	12	530.00

Duş kanalı / W200-330-400-500-600-800 mm / Ø 50 yan - alt çıkış
Plastik gövde / Paslanmaz ızgara / Sulu koku tutucu

PERA LEGAL

Ürün Kodu	Kısa Kod	Çıkış	Ölçü		Fiyat
YAN ÇIKIŞ					
3158.SY050K.033.1	32475	Ø 50	30 cm	12	446.70
3158.SY050K.040.1	32476	Ø 50	40 cm	12	516.70
3158.SY050K.050.1	32477	Ø 50	50 cm	12	656.70
3158.SY050K.060.1	32478	Ø 50	60 cm	12	730.00
3158.SY050K.080.1	32479	Ø 50	80 cm	12	883.40
ALT ÇIKIŞ					
3158.SA050K.033.1	32480	Ø 50	30 cm	12	446.70
3158.SA050K.040.1	32481	Ø 50	40 cm	12	516.70
3158.SA050K.050.1	32482	Ø 50	50 cm	12	656.70
3158.SA050K.060.1	32483	Ø 50	60 cm	12	730.00
3158.SA050K.080.1	32484	Ø 50	80 cm	12	883.40

Duş kanalı / W200-330-400-500-600-800 mm / Ø 50 yan - alt çıkış
Paslanmaz gövde / Paslanmaz ızgara / Sulu koku tutucu

STANDART LINE

Ürün Kodu	Kısa Kod	Çıkış	Ölçü		Fiyat
YAN ÇIKIŞ					
4022.SY050K.033.1	32485	Ø 50	30 cm	12	353.40
4022.SY050K.040.1	32486	Ø 50	40 cm	12	383.40
4022.SY050K.050.1	32487	Ø 50	50 cm	12	453.40
4022.SY050K.060.1	32488	Ø 50	60 cm	12	500.00
4022.SY050K.080.1	32489	Ø 50	80 cm	12	580.00
ALT ÇIKIŞ					
4022.SA050K.033.1	32490	Ø 50	30 cm	12	353.40
4022.SA050K.040.1	32491	Ø 50	40 cm	12	383.40
4022.SA050K.050.1	32492	Ø 50	50 cm	12	453.40
4022.SA050K.060.1	32493	Ø 50	60 cm	12	500.00
4022.SA050K.080.1	32494	Ø 50	80 cm	12	580.00

Duş kanalı / W200-330-400-500-600-800 mm / Ø 50 yan - alt çıkış
Plastik gövde / Paslanmaz ızgara / Sulu koku tutucu



HM-27970

Pera koku tutucu kullanılmaktadır.



HM-27970

Pera koku tutucu kullanılmaktadır.



HM-31361

Uzun koku tutucu kullanılmaktadır.

PRIME LINE

Ürün Kodu	Kısa Kod	Çıkış	Ölçü	İkili	Fiyat
YAN ÇIKIŞ					
4023.SY050K.033.1	32495	Ø 50	33 cm	12	350.00
4023.SY050K.040.1	32496	Ø 50	40 cm	12	380.00
4023.SY050K.050.1	32497	Ø 50	50 cm	12	440.00
4023.SY050K.060.1	32498	Ø 50	60 cm	12	486.70
4023.SY050K.080.1	32499	Ø 50	80 cm	12	600.00
ALT ÇIKIŞ					
4023.SA050K.033.1	32500	Ø 50	33 cm	12	350.00
4023.SA050K.040.1	32501	Ø 50	40 cm	12	380.00
4023.SA050K.050.1	32502	Ø 50	50 cm	12	440.00
4023.SA050K.060.1	32503	Ø 50	60 cm	12	486.70
4023.SA050K.080.1	32504	Ø 50	80 cm	12	600.00

Duş kanalı / W200-330-400-500-600-800 mm / Ø 50 yan - alt çıkış
Plastik gövde / Paslanmaz ızgara / Sulu koku tutucu



HM-31360

Prime koku tutucu kullanılmaktadır.

TREND LINE

Ürün Kodu	Kısa Kod	Çıkış	Ölçü	İkili	Fiyat
YAN ÇIKIŞ					
4033.SY050K.033.1	32505	Ø 50	33 cm	12	560.00
4033.SY050K.040.1	32506	Ø 50	40 cm	12	620.00
4033.SY050K.050.1	32507	Ø 50	50 cm	12	773.40
4033.SY050K.060.1	32508	Ø 50	60 cm	12	863.40
4033.SY050K.080.1	32509	Ø 50	80 cm	12	1013.40
ALT ÇIKIŞ					
4033.SA050K.033.1	32510	Ø 50	33 cm	12	560.00
4033.SA050K.040.1	32511	Ø 50	40 cm	12	620.00
4033.SA050K.050.1	32512	Ø 50	50 cm	12	773.40
4033.SA050K.060.1	32513	Ø 50	60 cm	12	863.40
4033.SA050K.080.1	32514	Ø 50	80 cm	12	1013.40



HM-31361

Uzun koku tutucu kullanılmaktadır.

ELİT LEGAL

Ürün Kodu	Kısa Kod	Çıkış	Ölçü	İkili	Fiyat
YAN ÇIKIŞ					
4043.SY050K.033.1	32515	Ø 50	33 cm	12	853.40
4043.SY050K.040.1	32516	Ø 50	40 cm	12	950.00
4043.SY050K.050.1	32517	Ø 50	50 cm	12	1160.00
4043.SY050K.060.1	32518	Ø 50	60 cm	12	1313.40
4043.SY050K.080.1	32519	Ø 50	80 cm	12	1576.70
ALT ÇIKIŞ					
4043.SA050K.033.1	32520	Ø 50	33 cm	12	853.40
4043.SA050K.040.1	32521	Ø 50	40 cm	12	950.00
4043.SA050K.050.1	32522	Ø 50	50 cm	12	1160.00
4043.SA050K.060.1	32523	Ø 50	60 cm	12	1313.40
4043.SA050K.080.1	32524	Ø 50	80 cm	12	1576.70

Duş kanalı / W200-330-400-500-600 mm / Ø 50 yan - alt çıkış
Paslanmaz gövde / Paslanmaz ızgara / Sulu koku tutucu



HM-31363

Legal koku tutucu kullanılmaktadır.



HM-31361

Uzun koku tutucu kullanılmaktadır.

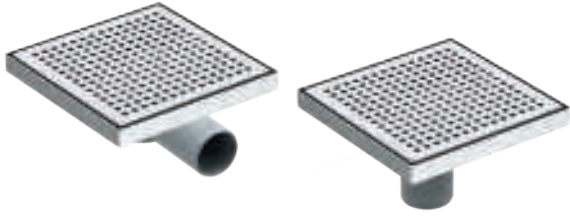

HM-31363

Legal koku tutucu kullanılmaktadır.



HM-31363

Legal koku tutucu kullanılmaktadır.

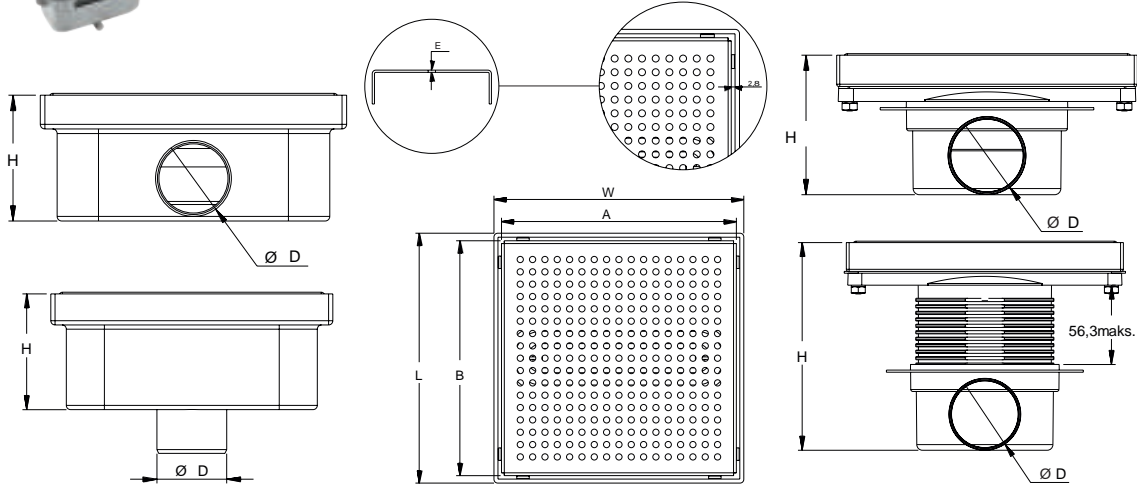

ÜRÜN KODU	W	L	H	Ø D	A	B	E
4072.0Y050K.020.0	200	200	82	49,5	188	188	1,5

ÜRÜN KODU	W	L	H	Ø D	A	B	E
4072.0A050K.020.0	200	200	82	49,5	188	188	1,5

LINE

Ürün Kodu	Kısa Kod	Çıkış	Ölçü	Fiyat
YAN ÇIKIŞ				
4072.0Y050K.020.1	18154	Ø 50	20x20 cm	370.00
ALT ÇIKIŞ				
4072.0A050K.020.1	18156	Ø 50	20x20 cm	370.00

Duş kanalı / 200x200 mm / Ø 50 yan - alt çıkış
Plastik gövde / Paslanmaz ızgara / Sulu koku tutucu

LEGAL

Ürün Kodu	Kısa Kod	Çıkış	Ölçü	Fiyat
YAN ÇIKIŞ				
4073.0Y050K.020.1	18160	Ø 50	20x20 cm	646.70
ALT ÇIKIŞ				
4073.0A050K.020.1	18164	Ø 50	20x20 cm	646.70

Duş kanalı / 200x200 mm / Ø 50 yan - alt çıkış
Paslanmaz gövde / Paslanmaz ızgara / Sulu koku tutucu

LEGAL Y360°

Ürün Kodu	Kısa Kod	Çıkış	Ölçü	Fiyat
YAN ÇIKIŞ				
4073.0Y360K.020.1	18176	Ø 50	20x20 cm	720.00
ALT ÇIKIŞ				
4073.0A360K.020.1	31400	Ø 50	20x20 cm	720.00

Duş kanalı / 200x200 mm / Ø 50 yan - alt çıkış
Paslanmaz gövde / Paslanmaz ızgara / Sulu koku tutucu



HM-31361
Uzun koku tutucu kullanılmaktadır.

LINE

Ürün Kodu	Kısa Kod	Çıkış	Ölçü		Fiyat
YAN ÇIKIŞ					
4062.0Y050K.033.1	18117	Ø 50	33 cm	12	336.70
ALT ÇIKIŞ					
4062.0A050K.033.1	18121	Ø 50	33 cm	12	336.70



HM-31363
Legal koku tutucu kullanılmaktadır.

LEGAL

Ürün Kodu	Kısa Kod	Çıkış	Ölçü		Fiyat
YAN ÇIKIŞ					
4063.0Y050K.033.1	18137	Ø 50	33 cm	12	566.70
ALT ÇIKIŞ					
4063.0A050K.033.1	18140	Ø 50	33 cm	12	566.70



HM-31363
Legal koku tutucu kullanılmaktadır.

LEGAL Y360°

Ürün Kodu	Kısa Kod	Çıkış	Ölçü		Fiyat
YAN ÇIKIŞ					
4063.0Y360K.033.1	18150	Ø 50	33 cm	12	640.00
ALT ÇIKIŞ					
4063.0A360K.033.1	31401	Ø 50	33 cm	12	640.00

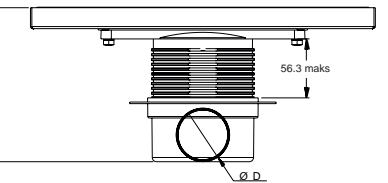
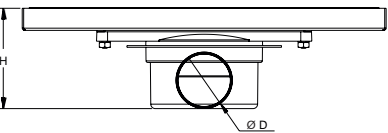
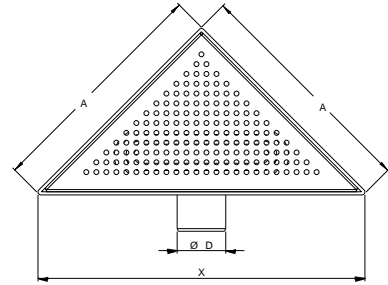
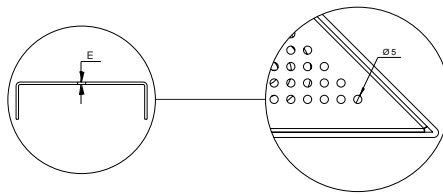
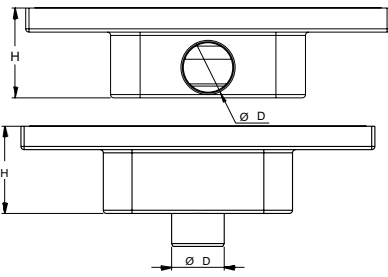

ÜRÜN KODU	H	Ø D	A	X	E
4062.0Y050K.033.0	84	49.5	234	330	1.5

ÜRÜN KODU	H	Ø D	A	X	E
4062.0A050K.033.0	84	49.5	234	330	1.5

ÜRÜN KODU	H	Ø D	A	X	E
4063.00360K.033.0	91	49.5	234	330	1.5

ÜRÜN KODU	H	Ø D	A	X	E
4063.0Y360K.033.0	147	49.5	234	330	1.5

Tablo ölçü birimi "mm"dir.



DOLU



KARE

KANAL OLUĞU 100x500 mm

Ürün Kodu	Kısa Kod	Ölçü	Yükseklik	Fiyat
BEYAZ				
7010.05005Y.0.0	13659	100x500 mm	50 mm	40
7011.05005A.0.0	13660	100x500 mm A.Ç.	50 mm	32
SİYAH				
7010.05005Y.0.S	26863	100x500 mm	50 mm	40
7011.05005A.0.S	26864	100x500 mm A.Ç.	50 mm	32



• Plastik gövde

PLASTİK KANAL IZGARASI 100x500mm

Ürün Kodu	Kısa Kod	Ölçü	Yükseklik	Fiyat
BEYAZ				
7110.050120.0.0	13653	100x500 mm	-	40
SİYAH				
7110.050120.0.S	26865	100x500 mm	-	40

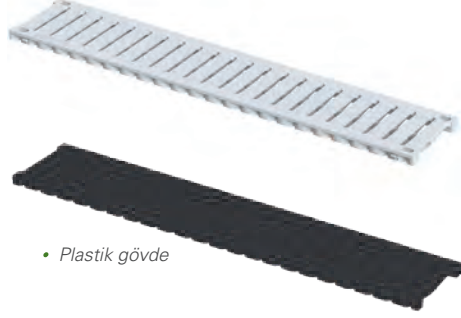

• Plastik gövde

PASLANMAZ KANAL IZGARASI 100x500 mm

Ürün Kodu	Kısa Kod	Ölçü	Kalite	Desen	Fiyat
2110.05012P.304.2	13745	100x500 mm	S.S.304	Kare	303.40
2110.10012P.304.2	13780	100x1000 mm	S.S.304	Kare	603.40
2110.05012G.430.1	13749	100x500 mm	Galvaniz	Kare	130.00
2110.05012G.430.2	13784	100x1000 mm	Galvaniz	Kare	253.40



• Paslanmaz Izgara

KANAL TAPASI 100 mm

Ürün Kodu	Kısa Kod	Ölçü	Yükseklik	Fiyat
BEYAZ				
7210.00050Y.0.0	13667	80x63 mm	-	150
SİYAH				
7210.00050Y.0.S	26866	80x63 mm	-	150

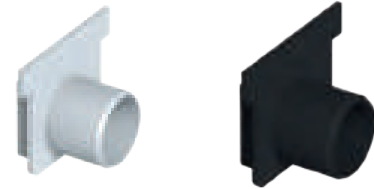

• Plastik gövde
• Ø 32 çıkış

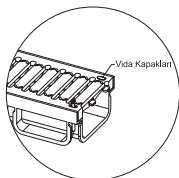
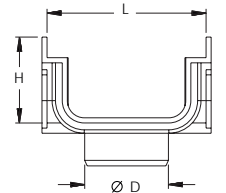
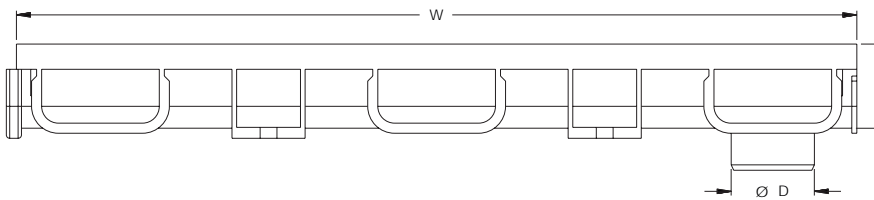
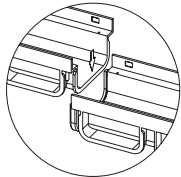
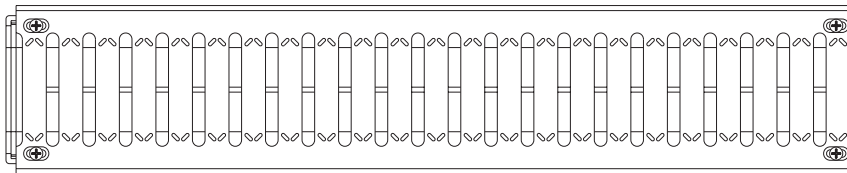
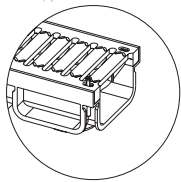

IZGARA DESEN SEÇENEKLERİ



PLASTİK

- PP
- AISI 304
- AISI 430
- Galvaniz
- Sfero Döküm



KARE

- AISI 304
- AISI 430
- Galvaniz

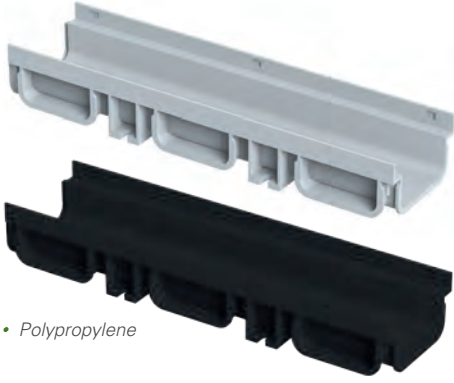

• Polypropylene

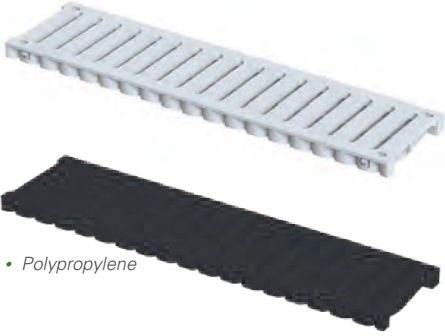

• Polypropylene



• Paslanmaz



• Pisk Döküm



7212.00070Y.0.0

7227.00070Y.0.0

7228.00070Y.0.0



7212.00070Y.0.S

7227.00070Y.0.S

7228.00070Y.0.S

• Polypropylene
• Ø 50 çıkış

KANAL OLUĞU 130x500 mm

Ürün Kodu	Kısa Kod	Ölçü	Yükseklik	Çıkış	Fiyat	
BEYAZ						
7013.05008Y.0.0	13661	130x500 mm	75 mm	-	40	86.70
7014.05008A.0.0	13662	130x500 mm A.Ç.	75 mm	Ø 49.5 / 74.5	32	93.40
SİYAH						
7013.05008Y.0.0	25118	130x500 mm	75 mm	-	40	86.70
7014.05008A.0.0	25119	130x500 mm A.Ç.	75 mm	Ø 49.5 / 74.5	32	93.40

PLASTİK KANAL IZGARASI 130x500mm

Ürün Kodu	Kısa Kod	Ölçü	Yükseklik	Fiyat	
BEYAZ					
7113.050200.0.0	13655	130x500 mm	-	40	83.40
SİYAH					
7113.050200.0.S	25120	130x500 mm	-	40	83.40

PASLANMAZ KANAL IZGARASI

Ürün Kodu	Kısa Kod	Ölçü	Kalite	Desen	Fiyat	
130x500 MM						
2113.05020P.304.2	13811	130x500 mm	S.S.304	Kare	1	406.70
2113.05020P.304.4	13788	130x500 mm	S.S.304	Standart		323.40
130x1000 MM						
2113.10020P.304.2	13833	130x1000 mm	S.S.304	Kare		813.40
2113.10020P.304.4	13821	130x1000 mm	S.S.304	Standart		640.00
GALVANİZ						
2113.05020P.430.4	13797	130x500 mm	Galvaniz	Standart		136.70
2113.10021P.430.4	13825	130x1000 mm	Galvaniz	Standart		273.40

SFERO DÖKÜM KANAL IZGARASI 130x500mm

Ürün Kodu	Kısa Kod	Ölçü	Desen	Fiyat	
2113.05020D.000.4	18172	130x500 mm	Standart	1	720.00

KANAL TAPASI 130 mm

Ürün Kodu	Kısa Kod	Ölçü	Açıklama	Fiyat	
BEYAZ					
7212.00070Y.0.0	13668	125x75 mm	Erkek tapa çıkışlı	150	26.70
7227.00070Y.0.0	13669	125x75 mm	Dişi tapa	150	26.70
7228.00070Y.0.0	13670	125x75 mm	Dişi tapa çıkışlı	150	26.70
SİYAH					
7212.00070Y.0.S	26104	125x75 mm	Erkek tapa çıkışlı	150	26.70
7227.00070Y.0.S	27108	125x75 mm	Dişi tapa	150	26.70
7228.00070Y.0.S	27109	125x75 mm	Dişi tapa çıkışlı	150	26.70

DRENAJ KANALLARI

MAXIFLOW
Maksimum akış...

KANAL OLUĞU 130x1000 mm

Ürün Kodu	Kısa Kod	Ölçü	Yükseklik	Çıkış	Fiyat	
BEYAZ						
7015.10010Y.0.0	13663	130x1000 mm	100 mm	-	20	193.40
7016.10010A.0.0	13664	130x1000 mm A.Ç.	100 mm	Ø 49.5 / 74.5	16	206.70
SİYAH						
7015.10010Y.0.S	27104	130x1000 mm	100 mm	-	20	193.40
7016.10010A.0.S	27105	130x1000mmA.Ç.	100 mm	Ø 49.5 / 74.5	16	206.70

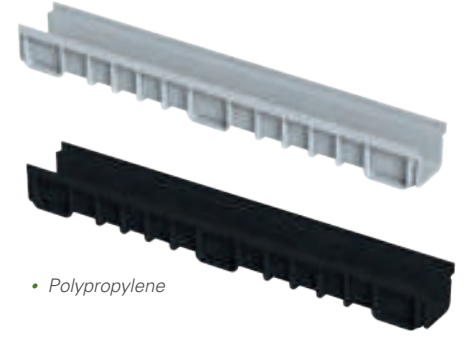

• Polypropylene

PLASTİK KANAL IZGARASI 130x500mm

Ürün Kodu	Kısa Kod	Ölçü	Yükseklik	Fiyat	
BEYAZ					
7113.050200.0.0	13655	130x500 mm	-	40	83.40
SİYAH					
7113.050200.0.S	25120	130x500 mm	-	40	83.40

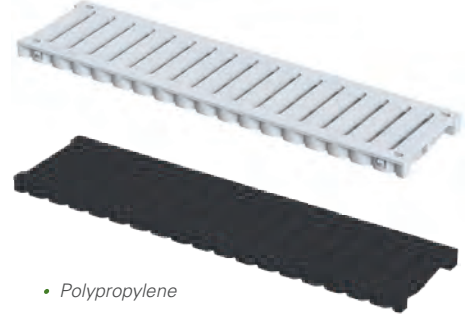

• Polypropylene

KANAL TAPASI 130 mm

Ürün Kodu	Kısa Kod	Ölçü	Açıklama	Fiyat	
BEYAZ					
7213.00100Y.0.B	13671	125x100 mm	Erkek tapa çıkışlı	150	26.70
7230.00100Y.0.B	13672	125x100 mm	Dişi tapa	150	26.70
7231.00100Y.0.B	13673	125x100 mm	Dişi tapa çıkışlı	150	26.70
SİYAH					
7213.00100Y.0.S	27112	125x100 mm	Erkek tapa çıkışlı	150	26.70
7230.00100Y.0.S	27110	125x100 mm	Dişi tapa	150	26.70
7231.00100Y.0.S	27111	125x100 mm	Dişi tapa çıkışlı	150	26.70



7213.00100Y.0.0

7230.00100Y.0.0

7231.00100Y.0.0

7213.00100Y.0.S

7230.00100Y.0.S

7231.00100Y.0.S

• Polypropylene
• Ø 70 çıkış

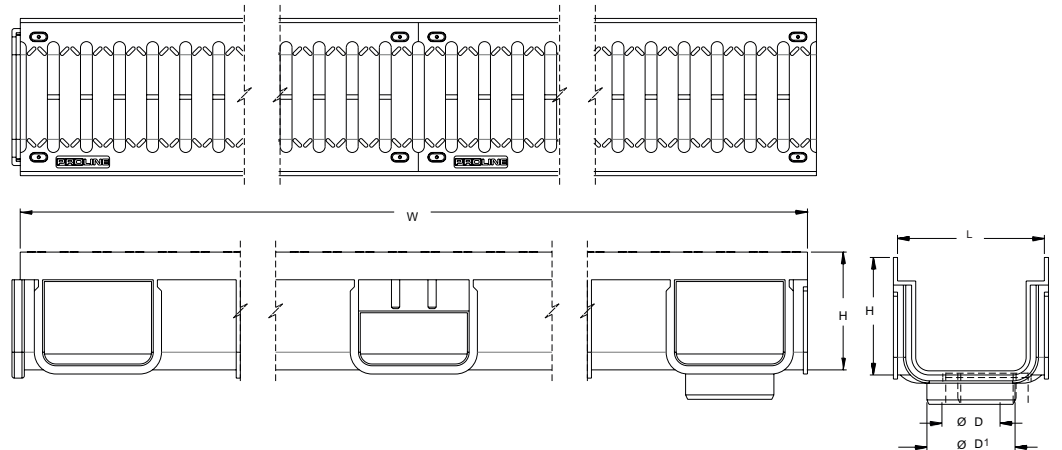
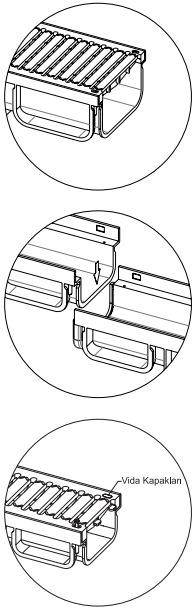

IZGARA DESEN SEÇENEKLERİ

ÜRÜN KODU	W	L	H	Ø D	Ø D1
7015.10010Y.0.0	1000	125	75	-	-
7016.10010A.0.0	1000	125	75	49.5	74.5



PLASTİK



KARE

• PP
• AISI 304
• AISI 430
• Galvaniz
• Stero Döküm

• AISI 304
• AISI 430
• Galvaniz

KANAL OLUĞU 130x1000 mm



Ürün Kodu	Kısa Kod	Ölçü	Yükseklik	Çıkış	Fiyat
BEYAZ					
7017.10008A.0.0	30890	130x1000 mm	75 mm	Ø 49.5 / 74.5 / 99.5	190.00
SİYAH					
7317.10008A.0.S	30891	130x1000 mm	75 mm	Ø 49.5 / 74.5 / 99.5	193.40

PLASTİK KANAL IZGARASI 130x1000mm



Ürün Kodu	Kısa Kod	Ölçü	Yükseklik	Fiyat
BEYAZ				
7114.100120.0.0	30892	130x1000 mm	-	166.70
SİYAH				
7414.100120.0.S	30893	130x1000 mm	-	170.00

KANAL TAPASI 130 mm

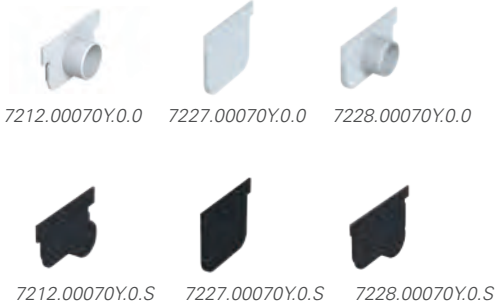

Ürün Kodu	Kısa Kod	Ölçü	Açıklama	Fiyat
BEYAZ				
7212.00070Y.0.0	13668	125x75 mm	Erkek tapa çıkışlı	26.70
7227.00070Y.0.0	13669	125x75 mm	Dişi tapa	26.70
7228.00070Y.0.0	13670	125x75 mm	Dişi tapa çıkışlı	26.70
SİYAH				
7212.00070Y.0.S	26104	125x75 mm	Erkek tapa çıkışlı	26.70
7227.00070Y.0.S	27108	125x75 mm	Dişi tapa	26.70
7228.00070Y.0.S	27109	125x75 mm	Dişi tapa çıkışlı	26.70

- Polypropylene
- Ø 50 çıkış

IZGARA DESEN SEÇENEKLERİ



PLASTİK

- PP
- AISI 304
- AISI 430
- Galvaniz
- Sfero Döküm



KARE

- AISI 304
- AISI 430
- Galvaniz

ÜRÜN KODU	W	L	H	Ø D	Ø D1
7015.10010Y.0.0	1000	125	75	-	-
7016.10010A.0.0	1000	125	75	49.5	74.5

KANAL OLUĞU 200x500 mm

Ürün Kodu	Kısa Kod	Ölçü	Yükseklik	Fiyat
BEYAZ				
7020.05013Y.0.0	13665	200x500 mm	120 mm	20
7020.05013A.0.0	13666	200x500 mm A.Ç.	120 mm	18
SİYAH				
7020.05013Y.0.S	26920	200x500 mm	120 mm	20
7020.05013A.0.S	26921	200x500 mm A.Ç.	120 mm	18



• Polypropylene

PLASTİK KANAL IZGARASI 200x500mm

Ürün Kodu	Kısa Kod	Ölçü	Yükseklik	Fiyat
BEYAZ				
7120.050200.0.0	13657	200x500 mm	-	20
SİYAH				
7120.050200.0.S	26922	200x500 mm	-	20

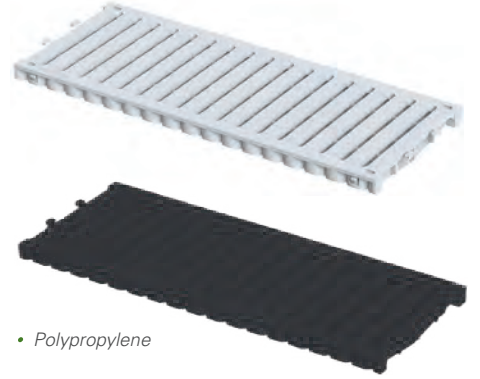

• Polypropylene

PASLANMAZ KANAL IZGARASI 200x500mm

Ürün Kodu	Kısa Kod	Ölçü	Kalite	Desen	Fiyat
2120.05021P.304.2	13861	200x500 mm	S.S.304	Kare	720.00
2120.05021P.304.3	13851	200x500 mm	S.S.304	Çizgi	720.00
2120.05021P.304.4	13840	200x500 mm	S.S.304	Standart	726.70
2120.05021P.430.4	13849	200x500 mm	GALVANİZ	Standart	320.00



• Paslanmaz

SFERO DÖKÜM KANAL IZGARASI 200x500mm

Ürün Kodu	Kısa Kod	Ölçü	Kalite	Desen	Fiyat
2120.05020D.000.4	18181	200x500 mm	Sfero Döküm	Standart	1163.40



• Pısk Döküm

KANAL TAPASI 200 mm

Ürün Kodu	Kısa Kod	Ölçü	Fiyat
BEYAZ			
7220.00120Y.0.0	13674	200x500 mm	150
SİYAH			
7220.00120Y.0.S	27083	200x500 mm	150



• Polypropylene
• Ø 70 çıkış



- Plastik gövde
- Plastik çerçeve



- Plastik gövde
- Plastik çerçeve

RÖGAR KAPAK TAKIMI

Ürün Kodu	Kısa Kod	Ölçü		Fiyat
2601.222200.141.T	13758	22x22 cm	1	96.70
2601.333300.142.T	13760	33x33 cm	1	163.40
2601.393900.146.T	13763	39x39 cm	1	306.70

PASLANMAZ RÖGAR KAPAK TAKIMI

Ürün Kodu	Kısa Kod	Ölçü		Fiyat
2603.4040A0.050.P	32525	40x40 cm	1	3496.70
2603.5050A0.050.P	32526	50x50 cm	1	4820.00
2603.6060A0.050.P	32527	60x60 cm	1	6113.40



20x20 ÇAMUR SIFON

Ürün Kodu	Kısa Kod	Çıkış	Ölçü	Fiyat	
YAN ÇIKIŞ					
1101.2020Y0.070.0	13748	Ø 70	20x20 cm	30	146.70
ALT ÇIKIŞ					
1101.2020A0.070.0	13750	Ø 70	20x20 cm	30	140.00

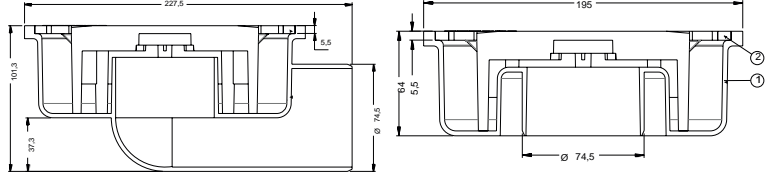

- Ø 70 yan - alt çıkış
- Plastik gövde
- Plastik ızgara

25x25 ÇAMUR SIFON

Ürün Kodu	Kısa Kod	Çıkış	Ölçü	Fiyat	
YAN ÇIKIŞ					
1101.2525Y0.100.0	13755	Ø 100	25x25 cm	20	210.00
ALT ÇIKIŞ					
1101.2525A0.100.0	13756	Ø 100	25x25 cm	20	200.00

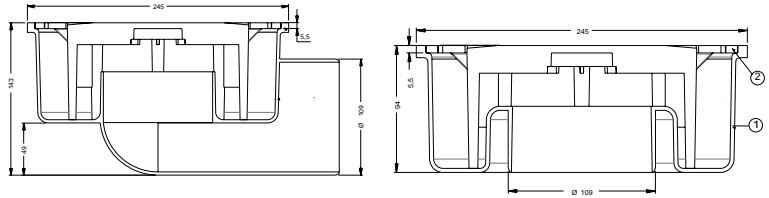

- Ø 100 yan - alt çıkış
- Plastik gövde
- Plastik ızgara

MAXIFLOW
Maksimum akış...

ENGELLI SERİSİ

ENGELLI SERİSİ

TUTUNMA BARI Ø 19

Ürün Kodu	Kısa Kod	Ölçü	Kalite		Fiyat
4819.1920P304.00	13549	8.5x20 cm	S.S. 304	1	186.70
4819.1930P304.00	13556	8.5x30 cm	S.S. 304	1	206.70
4819.1940P304.00	13557	8.5x40 cm	S.S. 304	1	226.70
4819.1950P304.00	13559	8.5x50 cm	S.S. 304	1	243.40
4819.1960P304.00	13560	8.5x60 cm	S.S. 304	1	260.00

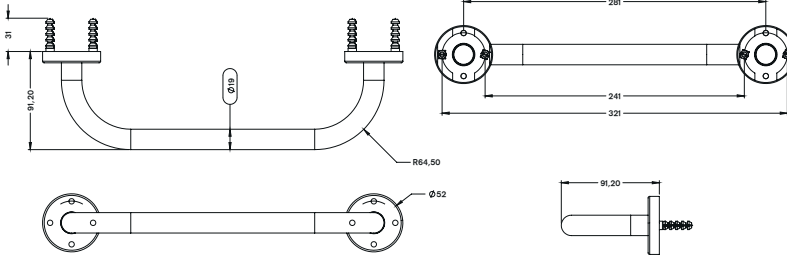

TUTUNMA BARI Ø 25

Ürün Kodu	Kısa Kod	Ölçü	Kalite		Fiyat
4819.2520P304.00	13561	8.5x20 cm	S.S. 304	1	223.40
4819.2530P304.00	13562	8.5x30 cm	S.S. 304	1	250.00
4819.2540P304.00	13563	8.5x40 cm	S.S. 304	1	270.00
4819.2550P304.00	13564	8.5x50 cm	S.S. 304	1	296.70
4819.2560P304.00	13565	8.5x60 cm	S.S. 304	1	323.40

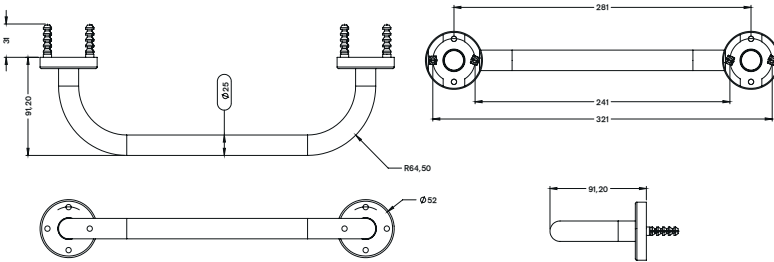

TUTUNMA BARI Ø 32

Ürün Kodu	Kısa Kod	Ölçü	Kalite		Fiyat
4819.3230P304.00	13566	10.5x30 cm	S.S. 304	1	353.40
4819.3240P304.00	13567	10.5x40 cm	S.S. 304	1	390.00
4819.3250P304.00	13568	10.5x50 cm	S.S. 304	1	423.40
4819.3260P304.00	13569	10.5x60 cm	S.S. 304	1	463.40

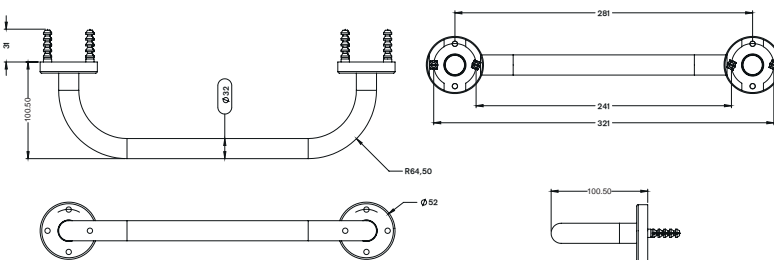

AÇILI TUTUNMA BARI



Ürün Kodu	Kısa Kod	Çap	Ölçü	Kalite		Fiyat
4826.1950P304.00	13570	Ø 19	13x40x8.5 cm	S.S. 304	1	236.70
4826.2564P304.00	13571	Ø 25	13x44x8.5 cm	S.S. 304	1	303.40
4826.3264P304.00	13572	Ø 32	22x64x10 cm	S.S. 304	1	480.00

AÇILI SÜNGERLİ TUTUNMA BARI



Ürün Kodu	Kısa Kod	Çap	Ölçü	Kalite		Fiyat
4827.1950P304.00	13573	Ø 19	13x40x10 cm	S.S. 304	1	440.00
4827.2550P304.00	13574	Ø 25	13x44x10 cm	S.S. 304	1	520.00

LAVABO TUTUNMA BARI



Ürün Kodu	Kısa Kod	Çap	Ölçü	Kalite		Fiyat
4838.7080P304.00	13575	Ø 32	76x74x80 cm	S.S. 304	1	2970.00

MAFSALLI AYAKLI



Ürün Kodu	Kısa Kod	Çap	Ölçü	Kalite		Fiyat
4828.7611P304.00	13576	Ø 32	75x73 cm	S.S. 304	1	2386.70

MAFSALLI STANDART

Ürün Kodu	Kısa Kod	Çap	Ölçü	Kalite	Fiyat
SS 304					
4832.2311P.304.00	13578	Ø 32	73x24x11 cm	SS 304	1 970.00
RENKLİ					
4832.2311B.101.00	28808	Ø 32	73x24x11 cm	BEYAZ	1 770.00
4832.2311S.102.00	28809	Ø 32	73x24x11 cm	SIYAH	1 770.00

• Tutunma barı

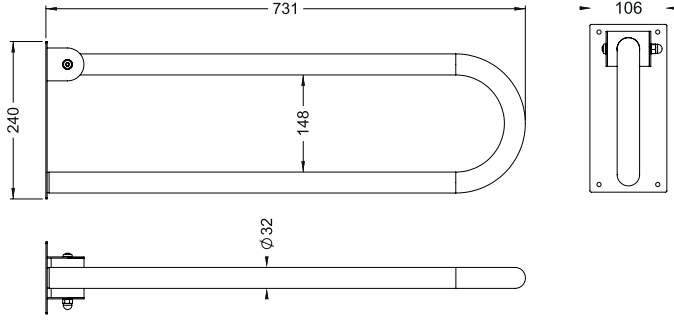

MAFSALLI WC KAĞITLIKLİ

Ürün Kodu	Kısa Kod	Çap	Ölçü	Kalite	Fiyat
SS 304					
4833.2311P.304.00	13579	Ø 32	73x24x11 cm	SS 304	1 1003.40
RENKLİ					
4833.2311B.101.00	28810	Ø 32	73x24x11 cm	BEYAZ	1 826.70
4833.2311S.102.00	28811	Ø 32	73x24x11 cm	SIYAH	1 826.70

• Tutunma barı

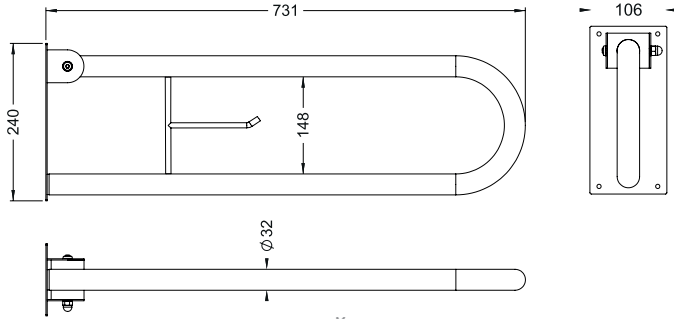

MAFSALLI WC KAĞITLIKLİ

Ürün Kodu	Kısa Kod	Çap	Ölçü	Kalite	Fiyat
SS 304					
4835.2311P.304.00	13580	Ø 32	73x24x11 cm	SS 304	1 1076.70
RENKLİ					
4835.2311B.101.00	28812	Ø 32	73x24x11 cm	BEYAZ	1 863.40
4835.2311S.102.00	28813	Ø 32	73x24x11 cm	SIYAH	1 863.40

• Tutunma barı

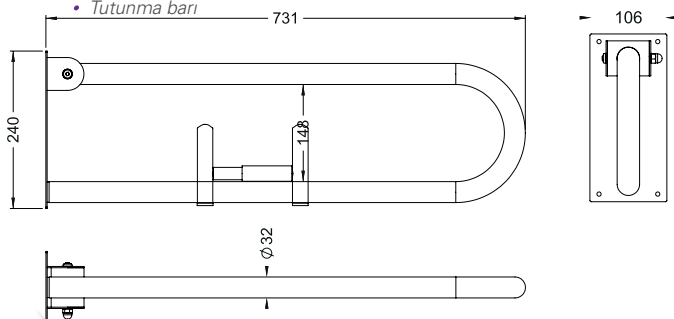



YERDEN DUVARA

Ürün Kodu	Kısa Kod	Çap	Ölçü	Kalite	Fiyat
SS 304					
4834.7500P.304.00	13581	Ø 32	75x75 cm	SS 304	636.70

• Tutunma bari

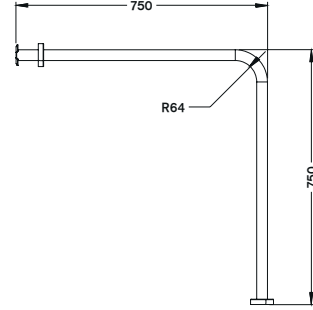

YERDEN DUVARA BASTON AYAK

Ürün Kodu	Kısa Kod	Çap	Ölçü	Kalite	Fiyat
SS 304					
4836.7500P.304.00	13582	Ø 32	75x75x30 cm	SS 304	873.40

• Tutunma bari

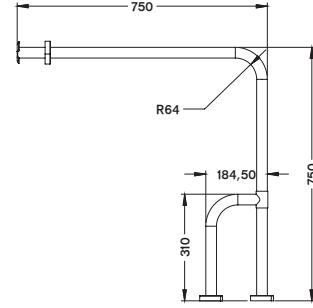

AÇILI TUTUNMA BARI KÖŞE

Ürün Kodu	Kısa Kod	Çap	Ölçü	Kalite	Fiyat
SS 304					
4831.4012P.304.00	13583	Ø 32	80x40x12 cm	SS 304	776.70

• Tutunma bari

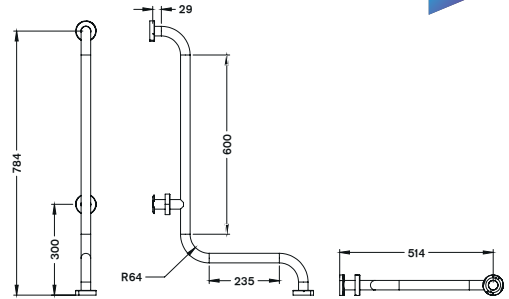

L TİPİ TUTUNMA BARI

Ürün Kodu	Kısa Kod	Çap	Ölçü	Kalite	Fiyat
SS 304					
4837.4012P.304.00	13584	Ø 32	80x40x12 cm	SS 304	776.70

• Tutunma bari

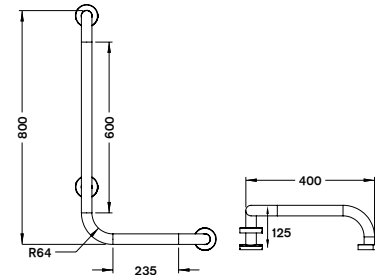

PLASTİK ENGELLİ DUŞ OTURAĞI



Ürün Kodu	Kısa Kod	Çap	Ölçü	Kalite	Fiyat
SS 304					
4820.4043S.304.00	13585	Ø 19	43x41.5x39.5 cm	SS 304 5	1246.70

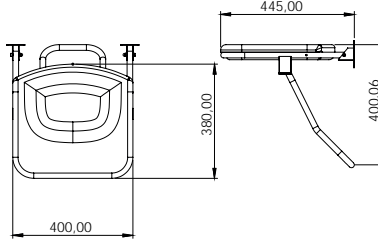

AHŞAP ENGELLİ DUŞ OTURAĞI



Ürün Kodu	Kısa Kod	Çap	Ölçü	Kalite	Fiyat
SS 304					
4820.4041S.304.00	13586	Ø 19	46x43.5x39 cm	SS 304 5	1626.70

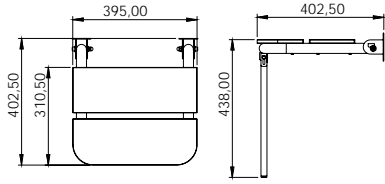

ENGELLİ AYNASI



Ürün Kodu	Kısa Kod	Ölçü	Kalite	Fiyat
SS 304				
4821.5070S.304.00	13587	50x70 cm	SS 304 5	1190.00

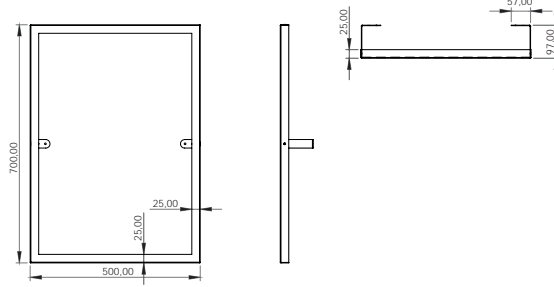

KULPLU ENGELLİ AYNASI



Ürün Kodu	Kısa Kod	Ölçü	Kalite	Fiyat
SS 304				
4840.5070S.304.00	13588	50x70 cm	SS 304 5	1213.40

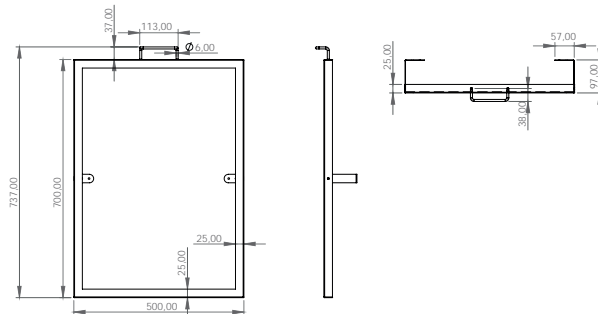

ÇÖP KOVALARI

ÇÖP KOVALARI



MICRO

Ürün Kodu	Kısa Kod	Çap	Yükseklik	Kalite	Fiyat
SS 430					
4501.1725M.430.03	13210	3 L Ø 17	24 cm	S.S. 430	8 236.70
4501.1825M.430.05	13212	5 L Ø 21	22 cm	S.S. 430	8 280.00



- Paslanmaz gövde
- Pedallı

STANDART PEDALLI ÇÖP KOVASI

Ürün Kodu	Kısa Kod	Çap	Yükseklik	Kalite	Fiyat
SS 430					
4501.1825S.430.03	13231	3 L Ø 21	22 cm	S.S. 430	8 280.00
4501.2028S.430.05	13234	5 L Ø 21	26 cm	S.S. 430	8 320.00
4501.2035S.430.08	13235	8 L Ø 21	35 cm	S.S. 430	6 403.40
4501.2435S.430.12	13236	12 L Ø 25	35 cm	S.S. 430	6 460.00
4501.2444S.430.16	13237	16 L Ø 25	44 cm	S.S. 430	4 626.70
4501.3135S.430.20	13238	20 L Ø 31	36 cm	S.S. 430	4 723.40
4501.3144S.430.30	13239	30 L Ø 31	45 cm	S.S. 430	4 863.40
4501.3163S.430.40	13240	40 L Ø 31	63 cm	S.S. 430	4 1093.40
SS 304					
4501.1825S.304.03	13241	3 L Ø 21	22 cm	S.S. 304	8 400.00
4501.2028S.304.05	13242	5 L Ø 21	26 cm	S.S. 304	8 453.40
4501.2035S.304.08	13243	8 L Ø 21	35 cm	S.S. 304	6 560.00
4501.2435S.304.12	13248	12 L Ø 25	35 cm	S.S. 304	6 650.00



- Paslanmaz gövde
- Pedallı

STANDART BOYALI ÇÖP KOVASI

Ürün Kodu	Kısa Kod	Çap	Yükseklik	Fiyat
BEYAZ				
4501.1825S.101.03	18199	3 L Ø 21	22 cm	8 300.00
4501.2028S.101.05	18204	5 L Ø 21	26 cm	8 323.40
4501.2035S.101.08	19855	8 L Ø 21	35 cm	6 420.00
4501.2435S.101.12	18208	12 L Ø 25	35 cm	6 473.40
4501.2444S.101.16	27520	16 L Ø 25	44 cm	4 603.40
4501.3135S.101.20	26002	20 L Ø 31	36 cm	4 746.70
4501.3144S.101.30	27526	30 L Ø 31	45 cm	4 796.70
4501.3163S.101.40	27532	40 L Ø 31	63 cm	4 1000.00
SİYAH				
4501.1825S.102.03	18197	3 L Ø 21	22 cm	8 300.00
4501.2028S.102.05	18202	5 L Ø 21	26 cm	8 323.40
4501.2035S.102.08	19858	8 L Ø 21	35 cm	6 420.00
4501.2435S.102.12	18207	12 L Ø 25	35 cm	6 473.40
4501.2444S.102.16	27523	16 L Ø 25	44 cm	4 603.40
4501.3135S.102.20	26005	20 L Ø 31	36 cm	4 746.70
4501.3144S.102.30	27528	30 L Ø 31	45 cm	4 796.70
4501.3163S.102.40	27534	40 L Ø 31	63 cm	4 1000.00
KIRMIZI				
4501.1825S.104.03	18201	3 L Ø 21	22 cm	8 300.00
4501.2028S.104.05	18206	5 L Ø 21	26 cm	8 323.40
4501.2035S.104.08	19856	8 L Ø 21	35 cm	6 420.00
4501.2435S.104.12	18210	12 L Ø 25	35 cm	6 473.40
4501.2444S.104.16	27521	16 L Ø 25	44 cm	4 603.40
4501.3135S.104.20	26003	20 L Ø 31	36 cm	4 746.70
4501.3144S.104.30	32592	30 L Ø 31	45 cm	4 796.70
4501.3163S.104.40	32593	40 L Ø 31	63 cm	4 1000.00



AMORTİSÖRLÜ KAPAK



- Paslanmaz gövde
- Pedallı

Ürün Kodu	Kısa Kod	Çap	Yükseklik	Kalite	Fiyat
SS 430					
4501.1825Y.430.03	13249	3 L Ø 21	22 cm	S.S. 430	8 333.40
4501.2028Y.430.05	13250	5 L Ø 21	26 cm	S.S. 430	8 353.40
4501.2035Y.430.08	13254	8 L Ø 21	35 cm	S.S. 430	6 436.70
4501.2435Y.430.12	13255	12 L Ø 25	35 cm	S.S. 430	6 493.40
4501.2444Y.430.16	13268	16 L Ø 25	44 cm	S.S. 430	4 636.70
4501.3135Y.430.20	21355	20 L Ø 31	36 cm	S.S. 430	4 810.00
4501.3144Y.430.30	21356	30 L Ø 31	45 cm	S.S. 430	4 920.00
4501.3163Y.430.40	21357	40 L Ø 31	63 cm	S.S. 430	4 1163.40
SS 304					
4501.1825Y.304.03	13256	3 L Ø 21	22 cm	S.S. 304	8 456.70
4501.2028Y.304.05	13260	5 L Ø 21	26 cm	S.S. 304	8 510.00
4501.2035Y.304.08	13261	8 L Ø 21	35 cm	S.S. 304	6 596.70
4501.2435Y.304.12	13262	12 L Ø 25	35 cm	S.S. 304	6 683.40

BOMBE KAPAK

- Paslanmaz gövde
- Pedallı



Ürün Kodu	Kısa Kod	Çap	Yükseklik	Kalite	Fiyat
SS 430					
4516.1825S.430.03	30816	3 L Ø 21	21 cm	S.S. 430	8 343.40
4516.2028S.430.05	30817	5 L Ø 21	27 cm	S.S. 430	8 366.70
4516.2035S.430.08	30818	8 L Ø 21	36 cm	S.S. 430	6 460.00
4516.2435S.430.12	30819	12 L Ø 25	36 cm	S.S. 430	6 530.00
4516.2444S.430.16	30820	16 L Ø 25	45 cm	S.S. 430	4 730.00
4516.3135S.430.20	30821	20 L Ø 31	37 cm	S.S. 430	4 873.40
4516.3144S.430.30	30822	30 L Ø 31	46 cm	S.S. 430	4 970.00
4516.3163S.430.40	30823	40 L Ø 31	64 cm	S.S. 430	4 1276.70
BEYAZ					
4516.1825S.101.03	30824	3 L Ø 21	21 cm		8 330.00
4516.2028S.101.05	30825	5 L Ø 21	27 cm		8 356.70
4516.2035S.101.08	30826	8 L Ø 21	36 cm		6 436.70
4516.2435S.101.12	30827	12 L Ø 25	36 cm		6 513.40
4516.2444S.101.16	30828	16 L Ø 25	45 cm		4 670.00
4516.3135S.101.20	30829	20 L Ø 31	37 cm		4 843.40
4516.3144S.101.30	30830	30 L Ø 31	46 cm		4 930.00
4516.3163S.101.40	30831	40 L Ø 31	64 cm		4 1200.00
SİYAH					
4516.1825S.102.03	30832	3 L Ø 21	21 cm		8 330.00
4516.2028S.102.05	30833	5 L Ø 21	27 cm		8 356.70
4516.2035S.102.08	30834	8 L Ø 21	36 cm		6 436.70
4516.2435S.102.12	30835	12 L Ø 25	36 cm		6 513.40
4516.2444S.102.16	30836	16 L Ø 25	45 cm		4 670.00
4516.3135S.102.20	30837	20 L Ø 31	37 cm		4 843.40
4516.3144S.102.30	30838	30 L Ø 31	46 cm		4 930.00
4516.3163S.102.40	30839	40 L Ø 31	64 cm		4 1200.00
KIRMIZI					
4516.1825S.104.03	32594	3 L Ø 21	21 cm		8 330.00
4516.2028S.104.05	32595	5 L Ø 21	27 cm		8 356.70
4516.2035S.104.08	32596	8 L Ø 21	36 cm		6 436.70
4516.2435S.104.12	32597	12 L Ø 25	36 cm		6 513.40
4516.2444S.104.16	32598	16 L Ø 25	45 cm		4 670.00
4516.3135S.104.20	32599	20 L Ø 31	37 cm		4 843.40
4516.3144S.104.30	32600	30 L Ø 31	46 cm		4 930.00
4516.3163S.104.40	32601	40 L Ø 31	64 cm		4 1200.00

PRATİK KAPAK

Ürün Kodu	Kısa Kod	Çap	Yükseklik	Kalite	Fiyat
SS 430					
4513.0000S.430.05	13269	5 L Ø 21	26 cm	S.S. 430 8	420.00
4513.0000S.430.08	13271	8 L Ø 21	32 cm	S.S. 430 8	513.40
4513.0000S.430.12	13272	12 L Ø 25	32 cm	S.S. 430 6	650.00
4513.0000S.430.16	13274	16 L Ø 25	38.5 cm	S.S. 430 6	700.00
4513.0000S.430.20	13275	20 L Ø 25	46.5 cm	S.S. 430 6	753.40
4513.0000S.430.27	13276	27 L Ø 25	57 cm	S.S. 430 6	853.40
4513.0000S.430.32	13277	32 L Ø 31	46 cm	S.S. 430 4	1030.00
4513.0000S.430.45	13278	45 L Ø 31	57 cm	S.S. 430 4	1163.40

SİYAH

4513.0000S.102.05	32543	5 L Ø 21	26 cm	S.S. 430 8	470.00
4513.0000S.102.08	28656	8 L Ø 21	32 cm	S.S. 430 8	520.00
4513.0000S.102.12	32544	12 L Ø 25	32 cm	S.S. 430 6	680.00
4513.0000S.102.16	32545	16 L Ø 25	38.5 cm	S.S. 430 6	753.40
4513.0000S.102.20	32546	20 L Ø 25	46.5 cm	S.S. 430 6	783.40
4513.0000S.102.27	28661	27 L Ø 25	57 cm	S.S. 430 6	820.00
4513.0000S.102.32	32547	32 L Ø 31	46 cm	S.S. 430 4	913.40
4513.0000S.102.45	28666	45 L Ø 31	57 cm	S.S. 430 4	1123.40

BEYAZ

4513.0000B.101.05	32528	5 L Ø 21	26 cm	S.S. 430 8	470.00
4513.0000B.101.08	28655	8 L Ø 21	32 cm	S.S. 430 8	520.00
4513.0000B.101.12	32529	12 L Ø 25	32 cm	S.S. 430 6	680.00
4513.0000B.101.16	32530	16 L Ø 25	38.5 cm	S.S. 430 6	753.40
4513.0000B.101.20	32531	20 L Ø 25	46.5 cm	S.S. 430 6	783.40
4513.0000B.101.27	28660	27 L Ø 25	57 cm	S.S. 430 6	820.00
4513.0000B.101.32	32532	32 L Ø 31	46 cm	S.S. 430 4	913.40
4513.0000B.101.45	28665	45 L Ø 31	57 cm	S.S. 430 4	1123.40



• Paslanmaz gövde



PRATİK ÇEMBERLİ

Ürün Kodu	Kısa Kod	Çap	Yükseklik	Kalite	Fiyat
SS 430					
4514.0000S.430.05	13279	5 L Ø 21	26 cm	S.S. 430 8	376.70
4514.0000S.430.08	13280	8 L Ø 21	32 cm	S.S. 430 8	426.70
4514.0000S.430.12	13281	12 L Ø 25	32 cm	S.S. 430 6	553.40
4514.0000S.430.16	13282	16 L Ø 25	38.5 cm	S.S. 430 6	603.40
4514.0000S.430.20	13283	20 L Ø 25	46.5 cm	S.S. 430 6	676.70
4514.0000S.430.27	13284	27 L Ø 25	57 cm	S.S. 430 6	760.00
4514.0000S.430.32	13285	32 L Ø 31	46 cm	S.S. 430 4	926.70
4514.0000S.430.45	13286	45 L Ø 31	57 cm	S.S. 430 4	1080.00

SİYAH

4514.0000S.102.05	32533	5 L Ø 21	26 cm	8	380.00
4514.0000S.102.08	28671	8 L Ø 21	32 cm	8	403.40
4514.0000S.102.12	32534	12 L Ø 25	32 cm	6	556.70
4514.0000S.102.16	32535	16 L Ø 25	38.5 cm	6	626.70
4514.0000S.102.20	32536	20 L Ø 25	46.5 cm	6	656.70
4514.0000S.102.27	28676	27 L Ø 25	57 cm	6	716.70
4514.0000S.102.32	32537	32 L Ø 31	46 cm	4	900.00
4514.0000S.102.45	28681	45 L Ø 31	57 cm	4	1033.40

BEYAZ

4514.0000S.101.05	32538	5 L Ø 21	26 cm	8	380.00
4514.0000S.101.08	28670	8 L Ø 21	32 cm	8	403.40
4514.0000S.101.12	32539	12 L Ø 25	32 cm	6	556.70
4514.0000S.101.16	32540	16 L Ø 25	38.5 cm	6	626.70
4514.0000S.101.20	32541	20 L Ø 25	46.5 cm	6	656.70
4514.0000S.101.27	28675	27 L Ø 25	57 cm	6	716.70
4514.0000S.101.32	32542	32 L Ø 31	46 cm	4	900.00
4514.0000S.101.45	28680	45 L Ø 31	57 cm	4	1033.40





- Paslanmaz gövde
- Kapaksız



- Paslanmaz gövde
- Paslanmaz kapak



- Paslanmaz gövde
- Paslanmaz kapak



- Paslanmaz gövde
- Paslanmaz kapak

KAPAKSIZ

Ürün Kodu	Kısa Kod	Çap	Yükseklik	Kalite	Fiyat
SS 430					
4503.1823S.430.03	13288	3 L Ø 21	19.5 cm	S.S. 430	8 196.70
4503.2026S.430.05	13289	5 L Ø 21	24 cm	S.S. 430	8 216.70
4503.2033S.430.08	13290	8 L Ø 21	33 cm	S.S. 430	6 296.70
4503.2433S.430.12	13291	12 L Ø 25	33 cm	S.S. 430	6 343.40
4503.2441S.430.16	13292	16 L Ø 25	42 cm	S.S. 430	4 440.00
SS 304					
4503.1823S.304.03	13293	3 L Ø 21	19.5 cm	S.S. 304	8 256.70
4503.2026S.304.05	13294	5 L Ø 21	24 cm	S.S. 304	8 286.70
4503.2035S.304.08	13295	8 L Ø 21	33 cm	S.S. 304	6 393.40
4503.2435S.304.12	13296	12 L Ø 25	33 cm	S.S. 304	6 450.00
OFİS TİPİ					
4506.2529S.000.00	13329	8 L Ø 21	23.5 cm	S.S. 430	8 266.70

ÇEMBERLİ

Ürün Kodu	Kısa Kod	Çap	Yükseklik	Kalite	Fiyat
SS 430					
4504.1924S.430.03	13298	3 L Ø 21	20.5 cm	S.S. 430	8 283.40
4504.2127S.430.05	13299	5 L Ø 21	24 cm	S.S. 430	8 300.00
4504.2034S.430.08	13300	8 L Ø 21	33 cm	S.S. 430	6 370.00
4504.2434S.430.12	13301	12 L Ø 25	33 cm	S.S. 430	6 446.70
4504.2442S.430.16	13302	16 L Ø 25	42 cm	S.S. 430	4 536.70
SS 304					
4504.1924S.304.03	13303	3 L Ø 21	20.5 cm	S.S. 304	8 356.70
4504.2127S.304.05	13304	5 L Ø 21	24 cm	S.S. 304	8 390.00
4504.2034S.304.08	13305	8 L Ø 21	33 cm	S.S. 304	6 473.40
4504.2434S.304.12	13306	12 L Ø 25	33 cm	S.S. 304	6 586.70

YANMAZ

Ürün Kodu	Kısa Kod	Çap	Yükseklik	Kalite	Fiyat
SS 430					
4507.2125S.430.08	13330	8 L Ø 21	25 cm	S.S. 430	8 336.70

KULPLU ÇÖP KOVASI

Ürün Kodu	Kısa Kod	Çap	Yükseklik	Kalite	Fiyat
SS 430					
4502.2028S.430.05	29856	5 L Ø 21	26 cm	S.S. 430	8 330.00

LÜKS KARE PEDALLI ÇÖP KOVASI

Ürün Kodu	Kısa Kod	Ölçü	Fiyat
SS 430			
4511.3040S.430.00	29718	24x28x50 cm	1940.00
RENKLİ			
4511.3040B.101.00	29719	BEYAZ 24x28x50 cm	1713.40
4511.3040S.102.00	29720	SİYAH 24x28x50 cm	1713.40



DÜZ KAPAK

Ürün Kodu	Kısa Kod	Yükseklik	Kalite	Fiyat
SS 430				
4513.2860S.430.0	13326 Ø 27	59.5 cm	S.S. 430	843.40
BEYAZ				
4513.2860S.101.B	28730 Ø 27	59.5 cm		836.70
SİYAH				
4513.2860S.102.S	28731 Ø 27	59.5 cm		836.70



BOMBE KAPAK

Ürün Kodu	Kısa Kod	Yükseklik	Kalite	Fiyat
SS 430				
4512.2867S.000.00	13327 Ø 27	62 cm	S.S. 430	823.40
BEYAZ				
4512.2867S.101.B	28735 Ø 27	62 cm		806.70
SİYAH				
4512.2867S.102.S	28736 Ø 27	62 cm		806.70



SALLANIR KAPAK



Ürün Kodu	Kısa Kod	Yükseklik	Kalite	Fiyat
SS 430				
4508.1528S.430.07	13309	7 L 15x17x27 cm	S.S. 430	506.70
4508.1839S.430.11	13310	11 L 18x20x38 cm	S.S. 430	766.70
4508.1850S.430.16	13311	16 L 18x20x49 cm	S.S. 430	940.00
4508.2448S.430.25	13312	25 L 24x28x50 cm	S.S. 430	1356.70
4508.2463S.430.36	13313	36 L 24x28x65 cm	S.S. 430	1590.00
4508.3055S.430.45	13314	45 L 30x35x55 cm	S.S. 430	1843.40
4508.3061S.430.54	13315	54 L 30x34x62 cm	S.S. 430	2000.00
4508.3089S.430.80	13316	80 L 30x35x90 cm	S.S. 430	2433.40



BEYAZ				
4508.1528B.101.07	28685	7 L 15x17x27 cm		440.00
4508.1839B.101.11	28690	11 L 18x20x38 cm		660.00
4508.1850B.101.16	28695	16 L 18x20x49 cm		816.70
4508.2448B.101.25	28700	25 L 24x28x50 cm		1123.40
4508.2463B.101.36	28705	36 L 24x28x65 cm		1383.40
4508.3055B.101.45	28710	45 L 30x35x55 cm		1610.00
4508.3061B.101.54	28715	54 L 30x34x62 cm		1713.40
4508.3089B.101.80	28720	80 L 30x35x90 cm		1986.70



RENKLİ SİYAH				
4508.1528S.102.07	28686	7 L 15x17x27 cm		440.00
4508.1839S.102.11	28691	11 L 18x20x38 cm		660.00
4508.1850S.102.16	28696	16 L 18x20x49 cm		816.70
4508.2448S.102.25	28701	25 L 24x28x50 cm		1123.40
4508.2463S.102.36	28706	36 L 24x28x65 cm		1383.40
4508.3055S.102.45	28711	45 L 30x35x55 cm		1610.00
4508.3061S.102.54	28716	54 L 30x34x62 cm		1713.40
4508.3089S.102.80	28721	80 L 30x35x90 cm		1986.70



Ürün Kodu	Kısa Kod	Yükseklik	Kalite	Fiyat
ZARF TİPİ				
SS 430				
4509.3090S.430.80	28725	80 L 30x35x90 cm	S.S. 430	2450.00
RENKLİ BEYAZ				
4509.3090B.101.80	28727	80 L 30x35x90 cm		1913.40
RENKLİ SİYAH				
4509.3090S.102.80	28728	80 L 30x35x90 cm		1913.40



Ürün Kodu	Kısa Kod	Yükseklik	Fiyat
AÇIK KAPAK			
SS 430			
4510.2463S.430.36	28795	36 L 42 cm	1346.70
BEYAZ			
4510.2463B.101.36	28790	36 L 42 cm	1183.40
SİYAH			
4510.2463S.102.36	28791	36 L 42 cm	1183.40

*Boyalı ürünlerde 500 Adet ve üzeri siparişlerde özel renk seçenekleri mevcuttur.

SET ÜSTÜ SIVI SABUNLUK

Ürün Kodu	Kısa Kod	Renk	Çap	Yükseklik	Fiyat	
PASLANMAZ SS 430						
4711.17.718.1	26460		Ø 7	17 cm	20	140.00
RENKLİ						
4711.18.71.B	26464	BEYAZ	Ø 7	17 cm	20	143.40
4711.18.71.S	26463	SİYAH	Ø 7	17 cm	20	143.40
4711.18.71.P	26462	PEMBE	Ø 7	17 cm	20	143.40
4711.18.71.K	26461	KIRMIZI	Ø 7	17 cm	20	143.40
4711.18.71.M	26671	MOR	Ø 7	17 cm	20	143.40



DIŞ FIRÇALIK

Ürün Kodu	Kısa Kod	Renk	Çap	Yükseklik	Fiyat	
PASLANMAZ SS 430						
4711.22.711.1	26455		Ø 7	12 cm	20	83.40
RENKLİ						
4711.22.711.B	26454	BEYAZ	Ø 7	12 cm	20	83.40
4711.22.711.S	26453	SİYAH	Ø 7	12 cm	20	83.40
4711.22.711.P	26452	PEMBE	Ø 7	12 cm	20	83.40
4711.22.711.K	26451	KIRMIZI	Ø 7	12 cm	20	83.40
4711.22.711.M	26672	MOR	Ø 7	12 cm	20	83.40



STANDART

Ürün Kodu	Kısa Kod	Renk	Fiyat	
SS 430 2'Lİ SET				
ST.0102.430.P	26441		6	433.40
BOYALI 2'Lİ SET				
ST.0402.101.B	26446	BEYAZ	6	433.40
ST.0302.102.S	26445	SİYAH	6	433.40
ST.0202.103.P	26444	PEMBE	6	433.40
ST.0102.104.K	26443	KIRMIZI	6	433.40
ST.0502.105.M	26669	MOR	6	433.40



STANDART

Ürün Kodu	Kısa Kod	Renk	Fiyat	
SS 430 4'LÜ SET				
ST.0104.430.P	26442		6	610.00
BOYALI 4'LÜ SET				
ST.0404.101.B	26450	BEYAZ	6	600.00
ST.0304.102.S	26449	SİYAH	6	600.00
ST.0204.103.P	26448	PEMBE	6	600.00
ST.0104.104.K	26447	KIRMIZI	6	600.00
ST.0504.105.M	26670	MOR	6	600.00





**YANMAZ
KOKUSUZ**

BORU TİPİ KÜLLÜK

Ürün Kodu	Kısa Kod	Çap	Yükseklik	Kalite	Fiyat
SS 304					
4418.1182S.304.00	18182	Ø 10.50	83 cm	S.S. 304	2310.00
BEYAZ					
4418.1182B.101.00	28780	Ø 10.50	83 cm		1206.70
SİYAH					
4418.1182S.102.00	28781	Ø 10.50	83 cm		1206.70



**YANMAZ
KOKUSUZ**

DEKORATİF KÜLLÜK

Ürün Kodu	Kısa Kod	Çap	Yükseklik	Kalite	Fiyat
4419.0709M.304.00	26457	Ø 7	10 cm	S.S. 304	176.70
4419.0709M.430.00	31410	Ø 7	10 cm	S.S. 430	140.00
BOYALI					
4419.0709M.101.00	28775	Ø 7	10 cm	BEYAZ	96.70
4419.0709M.102.00	28776	Ø 7	10 cm	SİYAH	96.70



STANDART KOLON KÜLLÜK

Ürün Kodu	Kısa Kod	Çap	Yükseklik		Fiyat
SS 430					
4418.1960S.430.00	13333	Ø 19	60 cm	S.S. 430	8 523.40
4418.2160S.430.00	13334	Ø 21	60 cm	S.S. 430	8 563.40
4418.2560S.430.00	13335	Ø 25	60 cm	S.S. 430	6 720.00
4418.2860S.430.00	13336	Ø 28	60 cm	S.S. 430	4 863.40
RENKLİ NO1					
4418.1960B.101.00	28740	Ø 19	60 cm	BEYAZ	8 516.70
4418.1960S.102.00	28741	Ø 19	60 cm	SİYAH	8 516.70
RENKLİ NO2					
4418.2160B.101.00	28745	Ø 21	60 cm	BEYAZ	8 566.70
4418.2160S.102.00	28746	Ø 21	60 cm	SİYAH	8 566.70
RENKLİ NO3					
4418.2560B.101.00	28750	Ø 25	60 cm	BEYAZ	6 720.00
4418.2560S.102.00	28751	Ø 25	60 cm	SİYAH	6 720.00
RENKLİ NO4					
4418.2860B.101.00	28755	Ø 28	60 cm	BEYAZ	4 853.40
4418.2860S.102.00	28756	Ø 28	60 cm	SİYAH	4 853.40



LÜKS KOLON KÜLLÜK

Ürün Kodu	Kısa Kod	Çap	Yükseklik		Fiyat
SS 430					
4417.1960S.430.00	29702	Ø 19	60 cm	S.S. 430	8 713.40
4417.2160S.430.00	29703	Ø 21	60 cm	S.S. 430	8 776.70
4417.2560S.430.00	29704	Ø 25	60 cm	S.S. 430	6 986.70
4417.2860S.430.00	29705	Ø 28	60 cm	S.S. 430	4 1180.00
RENKLİ NO1					
4417.1960B.101.00	29710	Ø 19	60 cm	BEYAZ	8 703.40
4417.1960S.102.00	29706	Ø 19	60 cm	SİYAH	8 703.40
RENKLİ NO2					
4417.2160B.101.00	29711	Ø 21	60 cm	BEYAZ	8 766.70
4417.2160S.102.00	29707	Ø 21	60 cm	SİYAH	8 766.70
RENKLİ NO3					
4417.2560B.101.00	29712	Ø 25	60 cm	BEYAZ	6 976.70
4417.2560S.102.00	29708	Ø 25	60 cm	SİYAH	6 976.70
RENKLİ NO4					
4417.2860B.101.00	29713	Ø 28	60 cm	BEYAZ	4 1163.40
4417.2860S.102.00	29709	Ø 28	60 cm	SİYAH	4 1163.40



YENİ!

LÜKS MİNİ İZGARALI KOLON KÜLLÜK

Ürün Kodu	Kısa Kod	Yükseklik	Kalite		Fiyat
SS 430					
4418.1458S.430.00	29734	Ø 14	58 cm	S.S. 430	8 656.70
BEYAZ					
4418.1458B.101.00	29736	Ø 14	58 cm		8 606.70
SİYAH					
4418.1458S.102.00	29735	Ø 14	58 cm		8 606.70



YENİ!



IZGARALI KOLON KÜLLÜK

Ürün Kodu	Kısa Kod	Çap	Yükseklik	Kalite	Fiyat
SS 430					
4513.2860I.430.0	13331	Ø 26	60 cm	S.S. 430	6 810.00



ŞAMPANYA KÜLLÜK

Ürün Kodu	Kısa Kod	Yükseklik	Kalite	Fiyat
SS 430				
4418.3165S.430.00	13340	Ø 32	61 cm	S.S. 430 4 703.40
RENKLİ BEYAZ				
4418.3165B.101.00	28765	Ø 32	61 cm	4 716.70
RENKLİ SİYAH				
4418.3165S.102.00	28766	Ø 32	61 cm	4 716.70

LÜKS ŞAMPANYA KÜLLÜK

Ürün Kodu	Kısa Kod	Yükseklik	Kalite	Fiyat
SS 430				
4420.3157S.430.00	29731	Ø 32	57 cm	S.S. 430 4 923.40
RENKLİ BEYAZ				
4420.3157B.101.00	29733	Ø 32	57 cm	4 943.40
RENKLİ SİYAH				
4420.3157S.102.00	29732	Ø 32	57 cm	4 943.40

LOBİ KÜLLÜK

Ürün Kodu	Kısa Kod	Yükseklik	Kalite	Fiyat
SS 430				
4418.2671S.430.00	13339	Ø 26	67 cm	S.S. 430 4 723.40
RENKLİ BEYAZ				
4418.2671B.101.00	28760	Ø 26	67 cm	4 663.40
RENKLİ SİYAH				
4418.2671S.102.00	28761	Ø 26	67 cm	4 663.40

YENİ!

U TİPİ

Ürün Kodu	Kısa Kod	Ölçü	Fiyat
DKP			
4505.5047S.000.00	13345	45x72.5x42 cm	1 1956.70

• Boyalı



BORU TİPİ

Ürün Kodu	Kısa Kod	Ölçü	Fiyat
DKP			
4539.5049U.000.00	13346	45x117 cm	1 1596.70

• Boyalı



ŞAPKALI

Ürün Kodu	Kısa Kod	Ölçü	Fiyat
DKP			
4539.5048S.000.00	13347	45x117x45 cm	1 2063.40

• Boyalı



BORU TİPİ DÜZ

Ürün Kodu	Kısa Kod	Ölçü	Fiyat
DKP			
4505.5045S.000.00	13348	45x100 cm	1 1553.40

• Boyalı



ŞAPKALI PASLANMAZ

Ürün Kodu	Kısa Kod	Ölçü	Fiyat
DKP + INOX			
4539.5048S.430.00	27287	45x117x45 cm	1 2203.40

• Boyalı
• Paslanmaz





KARE AYAKLI BAHÇE TİPİ ÇÖP KOVASI

Ürün Kodu	Kısa Kod	Ölçü	Fiyat
SS 430			
4418.30101S.430.00	29714	S.S. 430 30x26x102 cm	2290.00
RENKLİ			
4418.30101Y.106.00	29715	YEŞİL 30x26x102 cm	1913.40
4418.30101B.101.00	29716	SİYAH 30x26x102 cm	1913.40
4418.30101S.102.00	29717	BEYAZ 30x26x102 cm	1913.40



LÜKS IZGARALI DIŞ MEKAN ÇÖP KOVASI

Ürün Kodu	Kısa Kod	Ölçü	Fiyat
SS 430			
4505.5044S.430.00	29721	S.S. 430 45x72.5x42 cm	2263.40
DKP			
4505.5043S.000.00	29722	DKP 45x72.5x42 cm	2263.40



PASLANMAZ BAHÇE

Ürün Kodu	Kısa Kod	Ölçü	Fiyat
PASLANMAZ U TİPİ SS 304			
4518.50745.000.00	13350	50x47x74 cm	5153.40
PASLANMAZ ŞAPKALI SS 304			
4518.5099S.000.00	13349	50x48x115 cm	5223.40



ENDÜSTRİYEL ÇÖP KOVASI

Ürün Kodu	Kısa Kod	Ölçü	Fiyat
50 LT			
4515.4045S.430.50	19769	40x47 cm	2596.70
70 LT			
4515.4065S.430.70	19770	40x67 cm	3016.70



ÇEMBERLİ ENDÜSTRİYEL ÇÖP KOVASI

Ürün Kodu	Kısa Kod	Ölçü	Fiyat
50 LT			
4515.4045A.430.50	32548	40x47 cm	1733.40
70 LT			
4515.4045A.430.70	32549	40x67 cm	2173.40

ZARF KAPAK

Ürün Kodu	Kısa Kod	Ölçü	Kalite	Fiyat
SS 430 3'LÜ				
AT.101.3430.P	18251	111x35.5x92 cm	S.S. 430	8086.70
SS 430 4'LÜ				
AT.101.4430.P	23442	148x35.5x92 cm	S.S. 430	10756.70



ZARF KAPAK BOYALI

Ürün Kodu	Kısa Kod	Ölçü	Kalite	Fiyat
DKP 3'LÜ				
AT.101.3100.B	23433	111x35.5x92 cm	DKP	7073.40
DKP 4'LÜ				
AT.101.4100.B	23443	148x35.5x92 cm	DKP	9400.00



SALLANIR KAPAK

Ürün Kodu	Kısa Kod	Ölçü	Kalite	Fiyat
SS 430 3'LÜ				
AT.102.3430.P	18248	111x35.5x92 cm	S.S. 430	8170.00
SS 430 4'LÜ				
AT.102.4430.P	23439	148x35.5x92 cm	S.S. 430	10703.40



SALLANIR KAPAK BOYALI

Ürün Kodu	Kısa Kod	Ölçü	Kalite	Fiyat
DKP 3'LÜ				
AT.102.3100.B	18249	111x35.5x91 cm	DKP	7220.00
DKP 4'LÜ				
AT.102.4100.B	23440	148x35.5x91 cm	DKP	9596.70



BOMBE KAPAK

Ürün Kodu	Kısa Kod	Ölçü	Kalite	Fiyat
SS 430 3'LÜ				
AT.103.3430.P	13337	102x27x69.5 cm	S.S. 430	4060.00
SS 430 4'LÜ				
AT.103.4430.P	23435	130x27x69.5 cm	S.S. 430	5116.70



BOMBE KAPAK BOYALI

Ürün Kodu	Kısa Kod	Ölçü	Kalite	Fiyat
DKP 3'LÜ				
AT.103.3100.B	13338	102x27x69.5 cm	DKP	3763.40
DKP 4'LÜ				
AT.103.4100.B	23434	130x27x69.5 cm	DKP	4620.00



New



New

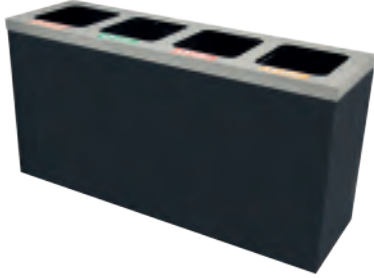

New



OVAL KAPAK

Ürün Kodu	Kısa Kod	Ölçü	Kalite		Fiyat
SS 430 3'LÜ					
AT.106.3430.P	32550	92x36x81 cm	S.S. 430	1	7266.70
SS 430 4'LÜ					
AT.106.4430.P	32551	123x36x81 cm	S.S. 430	1	8983.40

OVAL KAPAK BOYALI

Ürün Kodu	Kısa Kod	Ölçü	Kalite		Fiyat
DKP 3'LÜ					
AT.106.3103.B	32554	92x36x81 cm	DKP	1	5310.00
DKP 4'LÜ					
AT.106.4103.B	32555	123x36x81 cm	DKP	1	6396.70

KARE KAPAK

Ürün Kodu	Kısa Kod	Ölçü	Kalite		Fiyat
SS 430 3'LÜ					
AT.107.3430.P	32552	92x36x65 cm	S.S. 430	1	6290.00
SS 430 4'LÜ					
AT.107.4430.P	32553	92x36x65 cm	S.S. 430	1	7776.70

KARE KAPAK BOYALI

Ürün Kodu	Kısa Kod	Ölçü	Kalite		Fiyat
DKP 3'LÜ					
AT.107.3103.B	18249	92x36x65 cm	DKP	1	4630.00
DKP 4'LÜ					
AT.107.4103.B	23440	123x36x65 cm	DKP	1	5620.00

LÜKS KAPAK BOYALI

Ürün Kodu	Kısa Kod	Ölçü	Kalite		Fiyat
DKP 3'LÜ					
AT.110.3103.B	32556	92x36x73 cm	DKP	1	6450.00
DKP 4'LÜ					
AT.110.4103.B	32557	122x36x73 cm	DKP	1	7730.00

ÇEMBERLİ KAPAK

Ürün Kodu	Kısa Kod	Ölçü	Kalite	Fiyat
SS 430 3'LÜ				
AT.104.3430.P	18253	113.5x31x69.5 cm	S.S. 430	4686.70
SS 430 4'LÜ				
AT.104.4430.P	23436	150.5x31x69.5 cm	S.S. 430	5890.00

• Paslanmaz gövde



PRATİK KAPAK

Ürün Kodu	Kısa Kod	Ölçü	Kalite	Fiyat
SS 430 3'LÜ				
AT.105.3430.P	18242	113.5x31x69.5 cm	S.S. 430	5000.00
SS 430 4'LÜ				
AT.105.4430.P	23437	150.5x31x69.5 cm	S.S. 430	6170.00

• Paslanmaz gövde



Çöpler atık değil
geri kazanılmayı bekleyen hammaddelerdir.



WC FIRÇALIKLAR

DÜZ KAPAK

Ürün Kodu	Kısa Kod	Çap	Yükseklik	Kalite	İkisi	Fiyat
KF01.430K.36	13382	Ø 8	H.37 cm	S.S. 430	20	120.00
KF06.304K.36	13383	Ø 8	H.37 cm	S.S. 304	20	156.70
KF07.304K.36	13385	Ø 9	H.37 cm	S.S. 304	20	180.00
KF08.430K.36	13386	Ø 9	H.37 cm	S.S. 430	20	140.00

ASKILI

KF15.430K.36	13400	Ø 8	H.37 cm	S.S. 430	20	153.40
KF16.304K.36	13399	Ø 8	H.37 cm	S.S. 304	20	186.70
KF17.304K.36	13401	Ø 9	H.37 cm	S.S. 304	20	210.00
KF18.430K.36	13402	Ø 9	H.37 cm	S.S. 430	20	166.70



• Paslanmaz gövde

AKILLI KAPAK EKO

Ürün Kodu	Kısa Kod	Çap	Ölçü	Kalite	İkisi	Fiyat
KF64.430K.36	27281	Ø 8	H.37 cm	S.S. 430	20	140.00
KF66.304K.36	32558	Ø 8	H.37 cm	S.S. 304	20	173.40
KF67.304K.36	32590	Ø 9	H.37 cm	S.S. 304	20	186.70
KF65.430K.36	27285	Ø 9	H.37 cm	S.S. 430	20	146.70

ASKILI

KF20.430K.36	27281	Ø 8	H.37 cm	S.S. 430	20	166.70
KF21.304K.36	32559	Ø 8	H.37 cm	S.S. 304	20	203.40
KF22.304K.36	32591	Ø 9	H.37 cm	S.S. 304	20	213.40
KF23.430K.36	27285	Ø 9	H.37 cm	S.S. 430	20	173.40



• Paslanmaz gövde

BOMBE KAPAK

Ürün Kodu	Kısa Kod	Çap	Yükseklik	Kalite	İkisi	Fiyat
KF25.430K.36	13388	Ø 8	H.38 cm	S.S. 430	20	136.70
KF26.304K.36	13387	Ø 8	H.38 cm	S.S. 304	20	176.70
KF27.304K.36	13389	Ø 9	H.38 cm	S.S. 304	20	196.70
KF28.430K.36	13390	Ø 9	H.38 cm	S.S. 430	20	153.40

ASKILI

KF35.430K.36	13405	Ø 8	H.38 cm	S.S. 430	20	163.40
KF36.304K.36	13404	Ø 8	H.38 cm	S.S. 304	20	203.40
KF37.304K.36	13406	Ø 9	H.38 cm	S.S. 304	20	226.70
KF38.430K.36	13407	Ø 9	H.38 cm	S.S. 430	20	180.00



• Paslanmaz gövde

DÜZ KAPAK DELİKLİ

Ürün Kodu	Kısa Kod	Çap	Yükseklik	Kalite	İkisi	Fiyat
KF46.430K.36	13392	Ø 9	H.37 cm	S.S. 430	20	156.70
KF45.304K.36	13391	Ø 9	H.37 cm	S.S. 304	20	186.70

ASKILI

KF48.430K.36	13409	Ø 9	H.37 cm	S.S. 430	20	173.40
KF47.304K.36	13408	Ø 9	H.37 cm	S.S. 304	20	216.70



Ürünlerimiz



göre üretilmiştir.





Ürünlerimiz  göre üretilmiştir.

DELUXE

Ürün Kodu	Kısa Kod	Çap	Ölçü	Kalite		Fiyat
 KF69.304K.36	28807	Ø 8	H.39 cm	S.S. 304	20	393.40



PİRAMİT LÜKS

Ürün Kodu	Kısa Kod	Çap	Yükseklik	Kalite		Fiyat
 KF55.304K.36	13393	Ø 8	H.39 cm	S.S. 304	20	196.70
ASKILI						
KF56.304K.36	13410	Ø 8	H.39 cm	S.S. 304	20	213.40



BİYELİ

Ürün Kodu	Kısa Kod	Çap	Ölçü	Kalite		Fiyat
 KF61.304K.36	13395	Ø 9	H.39.5 cm	S.S. 304	20	283.40

AKILLI KAPAK SİLİKON FIRÇA

Ürün Kodu	Kısa Kod	Çap	Ölçü	Kalite		Fiyat
LUX						
 KF62.304K.36	13396	Ø 8	H.39 cm	S.S. 304	12	403.40
KARE						
KF63.304K.36	13397		37x8x8 cm	S.S. 304	12	563.40

AYAKLI WC FIRÇALIK SET

Ürün Kodu	Kısa Kod	Ölçü	Kalite		Fiyat
 KF68.304K.72	13398	H.80 cm	S.S. 430	8	753.40
RENKLİ					
KF68.101B.72	28802	H.80 cm	BEYAZ	8	760.00
KF68.102S.72	28803	H.80 cm	SİYAH	8	760.00

AKILLI KAPAK SİLİKONLU BOYALI FIRÇA

Ürün Kodu	Kısa Kod	Renk	Ölçü	Fiyat
KF63.101B.36	28797	Beyaz	H.37 cm	12 463.40
KF63.102S.36	28798	Siyah	H.37 cm	12 463.40



BOYALI WC FIRÇALIK

Ürün Kodu	Kısa Kod	Çap	Renk	Ölçü	Fiyat
KF90.101B.36	18236	Ø 8	Beyaz	H.37 cm	20 126.70
KF91.102S.36	18238	Ø 8	Siyah	H.37 cm	20 126.70
KF92.103P.36	18237	Ø 8	Pembe	H.37 cm	20 126.70
KF93.104K.36	18235	Ø 8	Kırmızı	H.37 cm	20 126.70
KF94.105M.36	27022	Ø 8	Mor	H.37 cm	20 126.70



ASKILI

KF10.101B.36	32560	Ø 8	Beyaz	H.37 cm	20 160.00
KF10.102S.36	32561	Ø 8	Siyah	H.37 cm	20 160.00
KF10.103P.36	32562	Ø 8	Pembe	H.37 cm	20 160.00
KF10.104K.36	32563	Ø 8	Kırmızı	H.37 cm	20 160.00
KF10.105M.36	32564	Ø 8	Mor	H.37 cm	20 160.00

HİJYENİK FIRÇA

Ürün Kodu	Kısa Kod	Renk	Fiyat
KF99.101.36	27143	Beyaz	20 166.70
KF98.102.36	27144	Siyah	20 166.70



*Fırça Sapı Fiyata Dahil Değildir.

HİJYENİK FIRÇA

Ürün Kodu	Kısa Kod	Çap	Yükseklik	Kalite	Fiyat
EKO SAPLI					
KF97.101.36	26458	Beyaz Ø 8.5	36x8x8 cm	S.S. 304	20 233.40
KF96.102.36	26459	Siyah Ø 8.5	36x8x8 cm	S.S. 304	20 233.40
LÜKS SAPLI					
KF95.101.36	27376	Beyaz Ø 9	36x8x8 cm	S.S. 304	20 263.40
KF94.102.36	27377	Siyah Ø 9	36x8x8 cm	S.S. 304	20 263.40



DUŞ SETLERİ



2
FONKSİYON

mono
FONKSİYON

SÜRGÜ
DUŞ
SİSTEMİ

DİRSEKLI
DUŞ
SİSTEMİ

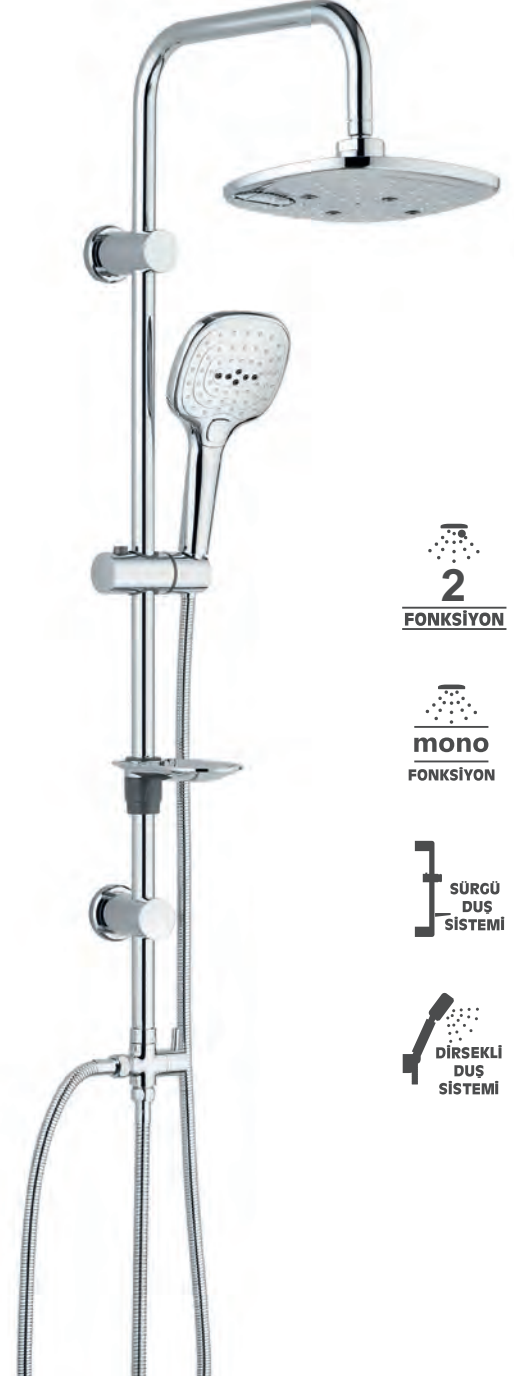

2
FONKSİYON

mono
FONKSİYON

SÜRGÜ
DUŞ
SİSTEMİ

DİRSEKLI
DUŞ
SİSTEMİ

ROBOT LONDRA

Ürün Kodu	Kısa Kod		Fiyat
4910.01150.LR.11	27654	8	2573.40

ROBOT PARİS

Ürün Kodu	Kısa Kod		Fiyat
4930.01150.PR.1	27656	8	2200.00

22 mm çapında paslanmaz çelik kromajlı "L" biçimli boru. Duş başlıkları orijinal ABS hammaddeden üretilmiştir. 250 mm tepe duşu ve 3 fonksiyonlu özel tasarım el duşu. Su tasarruf sistemi. Kireç kırıcı duş başlıkları. ½" - ½" 150-165cm. çift kenetli, paslanmaz çelik. EPDM hortumlu, kendinden contalı ve piriç bağlantı uçlu spiral. Ergonomik kristal sabunluk. Plastikten üretilmiş özel montaj ayağı görevi de gören krom kaplama yönlendirici. Her armatüre uyan adaptör ve montaj elemanları. Düşük su basınçlarında mükemmel su akışı sağlar. %50'ye kadar su tasarrufu sağlar. Özel yönlendiricisi ile tepe duşu ve el duşu geçişleri çok kolaydır. sızdırma yapmaz. Montajı kolaydır.



mono
FONKSİYON

SÜRGÜ
DUŞ
SİSTEMİ

DİRSEKLI
DUŞ
SİSTEMİ



5
FONKSİYON

mono
FONKSİYON

SÜRGÜ
DUŞ
SİSTEMİ

DİRSEKLI
DUŞ
SİSTEMİ

ROBOT RIO

Ürün Kodu	Kısa Kod	Fiyat
4960.01150.RR.1	27659	1843.40

ROBOT ROMA

Ürün Kodu	Kısa Kod	Fiyat
4970.01150.RR.1	27660	1730.00

22 mm çapında paslanmaz çelik kromajlı "L" biçimli boru. Duş başlıkları orijinal ABS hammaddeden üretilmiştir. 250 mm tepe duşu ve 3 fonksiyonlu özel tasarım el duşu. Su tasarruf sistemi. Kireç kırıcı duş başlıkları. 1/2" - 1/2" 150-165cm. çift kenetli. paslanmaz çelik. EPDM hortumlu. kendinden contalı ve piriç bağlantı uçlu spiral. Ergonomik kristal sabunluk. Plastikten üretilmiş özel montaj ayağı görevi de gören krom kaplama yönlendirici. Her armatüre uyan adaptör ve montaj elemanları. Düşük su basınçlarında mükemmel su akışı sağlar. %50'ye kadar su tasarrufu sağlar. Özel yönlendiricisi ile tepe duşu ve el duşu geçişleri çok kolaydır. sızdırma yapmaz. Montajı kolaydır.



3
FONKSİYON

mono
FONKSİYON

SÜRGÜ
DUŞ
SİSTEMİ

DİRSEKLI
DUŞ
SİSTEMİ

ROBOT İSTANBUL

Ürün Kodu	Kısa Kod		Fiyat
4980.01150.IR.1	27661	8	1690.00



2
FONKSİYON

SÜRGÜ
DUŞ
SİSTEMİ

DİRSEKLI
DUŞ
SİSTEMİ

SÜRGÜLÜ LONDRA

Ürün Kodu	Kısa Kod		Fiyat
4911.01150.LS.2	27662	20	1086.70



2
FONKSİYON

SÜRGÜ
DUŞ
SİSTEMİ

DİRSEKLI
DUŞ
SİSTEMİ

SÜRGÜLÜ PARIS

Ürün Kodu	Kısa Kod		Fiyat
4931.01150.PS.2	27664	20	703.40

22 mm çapında paslanmaz çelik kromajlı "L" biçimli boru. Duş başlıkları orijinal ABS ham maddeden üretilmiştir. 250 mm tepe duşu ve 3 fonksiyonlu özel tasarım el duşu. Su tasarruf sistemi. Kireç kırıcı duş başlıkları. ½" – ½" 150-165cm. çift kenetli, paslanmaz çelik. EPDM hortumlu, kendinden contalı ve piring bağlantılı uçlu spiral. Ergonomik kristal sabunluk. Plastikten üretilmiş özel montaj ayağı görevi de gören krom kaplama yönlendirici. Her armatüre uyan adaptör ve montaj elemanları. Düşük su basınçlarında mükemmel su akışı sağlar. %50'ye kadar su tasarrufu sağlar. Özel yönlendiricisi ile tepe duşu ve el duşu geçişleri çok kolaydır. sızdırma yapmaz. Montajı kolaydır.



3
FONKSİYON

SÜRGÜ
DUŞ
SİSTEMİ

DİRSEKLI
DUŞ
SİSTEMİ

SÜRGÜLÜ İSTANBUL

Ürün Kodu	Kısa Kod	Fiyat
4981.01150.IS.2	27669	20 383.40



5
FONKSİYON

SÜRGÜ
DUŞ
SİSTEMİ

DİRSEKLI
DUŞ
SİSTEMİ

SÜRGÜLÜ BERLİN

Ürün Kodu	Kısa Kod	Fiyat
4951.01150.BS.2	27666	20 476.70



mono
FONKSİYON

SÜRGÜ
DUŞ
SİSTEMİ

DİRSEKLI
DUŞ
SİSTEMİ

SÜRGÜLÜ RIO

Ürün Kodu	Kısa Kod	Fiyat
4961.01150.RS.2	27667	20 423.40



5
FONKSİYON

SÜRGÜ
DUŞ
SİSTEMİ

DİRSEKLI
DUŞ
SİSTEMİ

SÜRGÜLÜ ROMA

Ürün Kodu	Kısa Kod	Fiyat
4971.01150.RS.2	27668	20 423.40



5
FONKSİYON



MAFSALLI BERLİN

Ürün Kodu	Kısa Kod		Fiyat
4952.01150.BM.3	27670	28	373.40



3
FONKSİYON



MAFSALLI İSTANBUL

Ürün Kodu	Kısa Kod		Fiyat
4982.01150.IM.3	27671	28	210.00



mono
FONKSİYON



MAFSALLI BAKÜ

Ürün Kodu	Kısa Kod		Fiyat
4993.01150.BM.3	27672	28	186.70



New



15x15x210 cm

12x12x210 cm

mono
FONKSİYON

PASİFİK DUŞ KOLONU

Ürün Kodu	Kısa Kod	Ölçü	Fiyat
4957.01212.DK.1	32565	12x12x210 cm	9926.70
4957.01515.DK.1	32566	15x15x210 cm	12100.00

New



15x15x210 cm

12x12x210 cm

mono
FONKSİYON

ATLAS DUŞ KOLONU

Ürün Kodu	Kısa Kod	Ölçü	Fiyat
4957.01212.DK.2	32567	12x12x210 cm	10476.70
4957.01515.DK.2	32568	15x15x210 cm	12653.40



Parlak

DİŞ FIRÇALIK

Ürün Kodu	Kısa Kod	Ölçü	Fiyat
SS 304			
4711.22.711.0	13530	Ø 7x11 cm	20 160.00



Duvara
Montaj

Plastik
Pompa

Mat

Parlak

KÖPÜKLÜ

Ürün Kodu	Kısa Kod	Ölçü	Fiyat
SS 304			
4711.09.100.M	13411 Mat	1000 ml 22x6x13 cm	20 456.70
4711.09.100.P	13412 Parlak	1000 ml 22x6x13 cm	20 486.70



SET ÜSTÜ / ASKILIKLI

Ürün Kodu	Kısa Kod	Ölçü	Fiyat
SS 304			
4711.17.718.0	13413	Ø 7x17 cm	20 210.00
4711.16.717.0	13414 Askılı	Ø 7x17 cm	20 230.00



KÜRE SET ÜSTÜ

Ürün Kodu	Kısa Kod	Ölçü	Fiyat
SS 304			
4711.19.916.0	13416	Ø 9x14.5 cm	20 213.40



New



ANKASTRE

Ürün Kodu	Kısa Kod	Çap	Ölçü	Fiyat
SIVI SABUNLUK				
4716.0921S.304.00	13426	Ø 9	21 cm	20 290.00
KÖPÜKLÜ				
4716.0921S.304.01	13427	Ø 9	21 cm	20 990.00

ANKASTRE PİRİNÇ

Ürün Kodu	Kısa Kod	Çap	Ölçü	Fiyat
4716.0921S.304.02	32169	Ø 9	21 cm	20 673.40



SABUNLUK

Ürün Kodu	Kısa Kod	Ölçü	Fiyat
SS 304 500 ml 4711.02.050.P	13417	16x6x10 cm	20 353.40
SS 304 1000 ml 4711.06.100.P	13419	22x6x13 cm	20 433.40



SABUNLUK

Ürün Kodu	Kısa Kod	Ölçü	Fiyat
SS 304 500 ml 4711.01.050.M	13420	16x6x10 cm	20 343.40
SS 304 1000 ml 4711.05.100.M	13421	22x6x13 cm	20 430.00



SABUNLUK

Ürün Kodu	Kısa Kod	Ölçü	Fiyat
SS 304 500 ml 4711.04.050.P	13422	16x6x10 cm	20 366.70
SS 304 1000 ml 4711.08.100.P	13423	22x6x13 cm	20 466.70



SABUNLUK

Ürün Kodu	Kısa Kod	Ölçü	Fiyat
SS 304 500 ml 4711.03.050.M	13424	16x6x10 cm	20 356.70
SS 304 1000 ml 4711.07.100.M	13425	22x6x13 cm	20 456.70

ÇÖP KOVALI KAĞITLIK

Ürün Kodu	Kısa Kod	Ölçü	Kalite	Fiyat
OVAL 200 'LÜK				
4546.2010S.102.00	29847	105x27.5x12 cm	Siyah	1 1470.00
4546.2010B.101.00	29846	105x27.5x12 cm	Beyaz	1 1470.00
4546.2010S.430.00	29845	105x27.5x12 cm	SS 430	1 1730.00
OVAL 400 'LÜK				
4546.2610S.102.00	29851	105x27.5x12 cm	Siyah	1 1553.40
4546.2610B.101.00	29850	105x27.5x12 cm	Beyaz	1 1553.40
4546.2610S.430.00	13352	105x27.5x12 cm	SS 430	1 1853.40
DÜZ 200 'LÜK				
4549.2010S.102.00	29844	105x27.5x12 cm	Siyah	1 1476.70
4549.2010B.101.00	29843	105x27.5x12 cm	Beyaz	1 1476.70
4549.2010S.430.00	29842	105x27.5x12 cm	SS 430	1 1746.70
DÜZ 400 'LÜK				
4549.2610S.102.00	29849	105x27.5x12 cm	Siyah	1 1580.00
4549.2610B.101.00	29848	105x27.5x12 cm	Beyaz	1 1580.00
4549.2610S.430.00	13354	105x27.5x12 cm	SS 430	1 1870.00



ANKASTRE RAF

Ürün Kodu	Kısa Kod	Ölçü	Kalite	Fiyat
4550.3292R.102.02	32570	92x32x10 cm	Siyah	1 943.40
4550.3292R.101.02	32571	92x32x10 cm	Beyaz	1 943.40
4550.3292R.430.02	32572	92x32x10 cm	SS 430	1 1370.00

• Fabrika teslim Fiyatıdır.

New



MASAÜSTÜ KAĞITLIK

Ürün Kodu	Kısa Kod	Ölçü	Kalite	Fiyat
MINİ				
4924.1014S.430.00	32573	13,5x9x3 cm	SS 430	24 210.00
4924.1014S.304.00	32574	13,5x9x3 cm	SS 304	24 266.70
MAXİ				
4924.1325S.430.00	32575	25x13x6 cm	SS 430	12 443.40
4924.1325S.304.00	32576	25x13x6 cm	SS 304	12 543.40

New



KAPAKLI KAĞITLIK

Ürün Kodu	Kısa Kod	Ölçü	Kalite	Fiyat
AK.02.101A.B	32577	13x10x10 cm	Siyah	20 266.70
AK.02.102A.B	32578	13x10x10 cm	Beyaz	20 266.70
AK.02.430A.P	32579	13x10x10 cm	SS 430	20 353.40
AK.02.304A.P	32580	13x10x10 cm	SS 304	20 410.00

New



JUMBO WC KAĞIT VERİCİ



Ürün Kodu	Kısa Kod	Ölçü	Kalite		Fiyat
Ø 22					
4923.2212S.102.00	28900	12 cm	Siyah	20	386.70
4923.2212B.101.00	28899	12 cm	Beyaz	20	386.70
4923.2212S.430.00	13370	12 cm	SS 430	20	443.40
4923.2212S.304.00	13369	12 cm	SS 304	20	613.40
Ø 27					
4923.2712S.102.00	28902	12 cm	Siyah	20	413.40
4923.2712B.101.00	28901	12 cm	Beyaz	20	413.40
4923.2712S.430.00	13372	12 cm	SS 430	20	480.00
4923.2712S.304.00	13371	12 cm	SS 304	20	673.40

GÜLEN AĞIZ KAĞIT VERİCİ



Ürün Kodu	Kısa Kod	Ölçü	Kalite		Fiyat
4923.2739S.102.00	28906	28x5.5x39 cm	Siyah	12	293.40
4923.2739B.101.00	28905	28x5.5x39 cm	Beyaz	12	293.40
4923.2739S.430.00	13374	28x5.5x39 cm	SS 430	12	356.70
4923.2739S.304.00	13373	28x5.5x39 cm	SS 304	12	496.70

CİMRİ KAĞIT VERİCİ



Ürün Kodu	Kısa Kod	Ölçü	Kalite		Fiyat
4923.2013S.102.00	28904	Ø 21x13.5 cm	Siyah	12	543.40
4923.2013B.101.00	28903	Ø 21x13.5 cm	Beyaz	12	543.40
4923.2013S.304.00	13368	Ø 21x13.5 cm	SS 304	12	800.00

Z KATLAMA KAĞIT HAVLULUK



Ürün Kodu	Kısa Kod	Ölçü	Kalite		Fiyat
200 'LÜK					
4922.2026S.102.00	28896	20.5x27x10 cm	Siyah	20	393.40
4922.2026B.101.00	28895	20.5x27x10 cm	Beyaz	20	393.40
4922.2026P.430.00	13365	20.5x27x10 cm	SS 430	20	470.00
4922.2026P.304.00	13364	20.5x27x10 cm	SS 304	20	623.40
400 'LÜK					
4922.3226S.102.00	28898	27x35x10 cm	Siyah	20	490.00
4922.3226B.101.00	28897	27x35x10 cm	Beyaz	20	490.00
4922.3226P.430.00	13367	27x35x10 cm	SS 430	20	596.70
4922.3226P.304.00	13366	27x35x10 cm	SS 304	20	843.40

TEKLİ KOLLEKTÖR DOLABI

Ürün Kodu	Kısa Kod	Ölçü	Kalite	Fiyat	
4855.6025B.102.01	32571	60x25x15 cm	Siyah	1	1023.40
4855.6025B.101.01	32572	60x25x15 cm	Beyaz	1	1023.40

• Fabrika teslim Fiyatıdır.

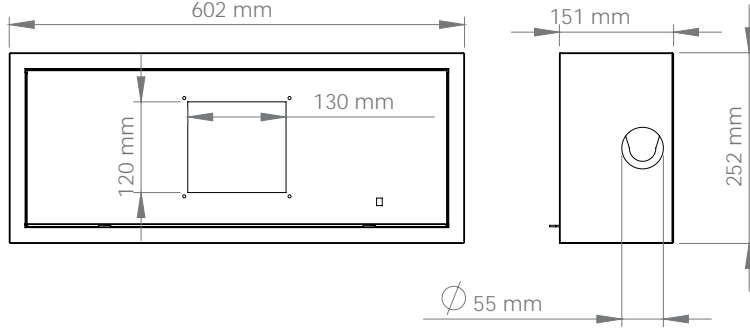

İKİLİ KOLLEKTÖR DOLABI

Ürün Kodu	Kısa Kod	Ölçü	Kalite	Fiyat	
4855.6032B.102.02	32573	60x32x15 cm	Siyah	1	1170.00
4855.6032B.101.02	32574	60x32x15 cm	Beyaz	1	1170.00

• Fabrika teslim Fiyatıdır.

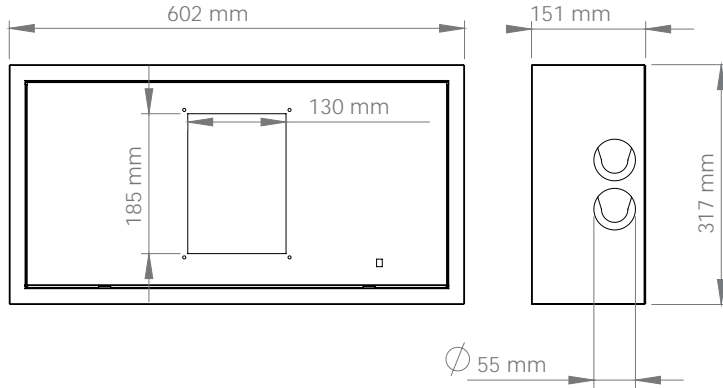

ÜÇLÜ KOLLEKTÖR DOLABI

Ürün Kodu	Kısa Kod	Ölçü	Kalite	Fiyat	
4855.6038B.102.03	32585	60x38x15 cm	Siyah	1	1320.00
4855.6038B.101.03	32586	60x38x15 cm	Beyaz	1	1320.00

• Fabrika teslim Fiyatıdır.

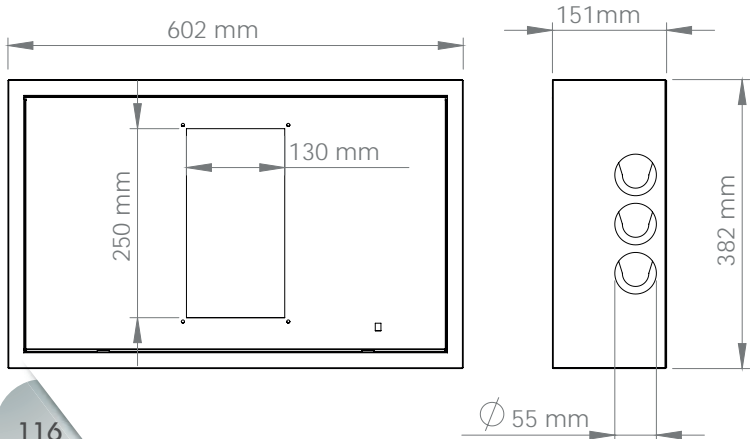



LAMALI RAF HAVLULUK

Ürün Kodu	Kısa Kod	Çap	Ölçü	Fiyat
SS 304 4949.3051S.304.00	13526	Ø 19	50x29x12.5 cm	12 686.70



RAF HAVLULUK

Ürün Kodu	Kısa Kod	Çap	Ölçü	Fiyat
SS 304 4949.3162S.304.00	13527	Ø 19	50x20x13 cm	25 540.00

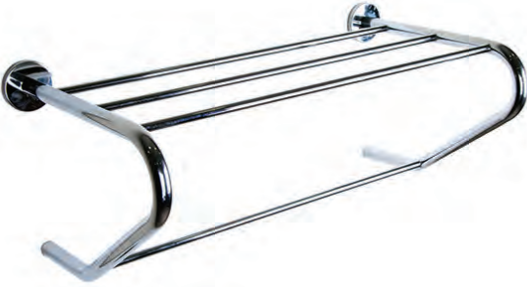

AÇILI DESTEKLİ RAF HAVLULUK

Ürün Kodu	Kısa Kod	Çap	Ölçü	Fiyat
SS 304 4950.5019S.304.00	13528	Ø 19	50x28x19 cm	12 653.40



DESTEKLİ RAF HAVLULUK

Ürün Kodu	Kısa Kod	Çap	Ölçü	Fiyat
SS 304 4950.3162S.304.00	13529	Ø 19	50x29x12 cm	12 640.00



ÇİFT KAT RAF HAVLULUK

Ürün Kodu	Kısa Kod	Ölçü	Fiyat
SS 304 4947.3051S.304.00	28893	50x27x13 cm	12 816.70



PASLANMAZ ETAJER

Ürün Kodu	Kısa Kod	Ölçü	Fiyat
SS 304 AK.161.4709.P	27288	47x9x4 cm	5 280.00
SS 304 KORUMALI AK.162.4710.P	27289	47x9x4 cm	5 480.00

LOFT KAPI KOLU Ø25

Ürün Kodu	Kısa Kod	Ölçü	Kalite	SS 304	Fiyat
4823.2530P.304.00	28824	8.5x30 cm	S.S. 304	5	240.00
4823.2540P.304.00	28825	8.5x40 cm	S.S. 304	5	263.40
4823.2550P.304.00	28826	8.5x50 cm	S.S. 304	5	290.00

LOFT KAPI KOLU Ø 32

Ürün Kodu	Kısa Kod	Ölçü	Kalite	SS 304	Fiyat
4823.3230P.304.00	28827	8x30 cm	S.S. 304	5	260.00
4823.3240P.304.00	28828	8x40 cm	S.S. 304	5	290.00
4823.3250P.304.00	28829	8x50 cm	S.S. 304	5	333.40

ROYAL KAPI KOLU Ø 25

Ürün Kodu	Kısa Kod	Ölçü	Kalite	SS 304	Fiyat
ROZETLİ					
4822.2540P.304.00	28814	8.5x40 cm	S.S. 304	5	313.40
4822.2550P.304.00	28815	8.5x50 cm	S.S. 304	5	340.00
4822.2560P.304.00	28816	8.5x60 cm	S.S. 304	5	363.40

ROYAL KAPI KOLU Ø 32

Ürün Kodu	Kısa Kod	Ölçü	Kalite	SS 304	Fiyat
ROZETLİ					
4822.3240P.304.00	28819	8x40 cm	S.S. 304	5	426.70
4822.3250P.304.00	28820	8x50 cm	S.S. 304	5	460.00
4822.3260P.304.00	28821	8x60 cm	S.S. 304	5	493.40





ETAJER

Ürün Kodu	Kısa Kod	İkon	Fiyat
AK.01.3901.P	13437	25	633.40



DİŞ FIRÇALIK

Ürün Kodu	Kısa Kod	İkon	Fiyat
AK.01.3904.P	13439	25	463.40



UZUN HAVLULUK

Ürün Kodu	Kısa Kod	İkon	Fiyat
AK.06.3914.P	13442	24	640.00



WC KAĞITLIK

Ürün Kodu	Kısa Kod	İkon	Fiyat
AK.04.3907.P	13444	48	393.40



SABUNLUK

Ürün Kodu	Kısa Kod	İkon	Fiyat
AK.01.3903.P	13438	25	463.40



BORNOZ ASKILIĞI

Ürün Kodu	Kısa Kod	İkon	Fiyat
AK.08.3927.P	13443	50	263.40



YUVARLAK HAVLULUK

Ürün Kodu	Kısa Kod	İkon	Fiyat
AK.01.3917.P	13440	26	463.40



WC KAPAKLI KAĞITLIK

Ürün Kodu	Kısa Kod	İkon	Fiyat
AK.05.3908.P	13445	36	523.40

- Krom kaplama
- Zamak gövde

- SS 304 kalite paslanmaz kapak ve boru
- Kutu ambalaj



ETAJER

Ürün Kodu	Kısa Kod		Fiyat
AK.11.3901.G	13446	25	766.70



DİŞ FIRÇALIK

Ürün Kodu	Kısa Kod		Fiyat
AK.13.3904.G	13448	25	600.00



UZUN HAVLULUK

Ürün Kodu	Kısa Kod		Fiyat
AK.16.3914.G	13450	24	830.00



WC KAĞITLIK

Ürün Kodu	Kısa Kod		Fiyat
AK.14.3907.G	13452	48	510.00

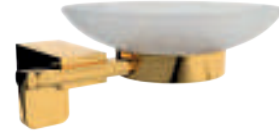

SABUNLUK

Ürün Kodu	Kısa Kod		Fiyat
AK.12.3903.G	13447	25	600.00



BORNOZ ASKILIĞI

Ürün Kodu	Kısa Kod		Fiyat
AK.18.3927.G	13451	50	343.40



YUVARLAK HAVLULUK

Ürün Kodu	Kısa Kod		Fiyat
AK.17.3917.G	13449	26	600.00



WC KAPAKLI KAĞITLIK

Ürün Kodu	Kısa Kod		Fiyat
AK.15.3908.G	13453	36	680.00





ETAJER

Ürün Kodu	Kısa Kod	İkon	Fiyat
AK.222.3901.B	30874	25	603.40



DİŞ FIRÇALIK

Ürün Kodu	Kısa Kod	İkon	Fiyat
AK.221.3904.B	30873	25	463.40



UZUN HAVLULUK

Ürün Kodu	Kısa Kod	İkon	Fiyat
AK.224.3914.B	30876	24	640.00



WC KAĞITLIK

Ürün Kodu	Kısa Kod	İkon	Fiyat
AK.225.3907.B	30877	48	393.40



SABUNLUK

Ürün Kodu	Kısa Kod	İkon	Fiyat
AK.223.3903.B	30875	25	463.40



BORNOZ ASKILIĞI

Ürün Kodu	Kısa Kod	İkon	Fiyat
AK.220.3927.B	30872	50	263.40



YUVARLAK HAVLULUK

Ürün Kodu	Kısa Kod	İkon	Fiyat
AK.227.3917.B	30879	26	463.40



WC KAPAKLI KAĞITLIK

Ürün Kodu	Kısa Kod	İkon	Fiyat
AK.226.3908.B	30878	36	523.40



ETAJER

Ürün Kodu	Kısa Kod		Fiyat
AK.74.3801.P	13474	20	290.00



DİŞ FIRÇALIK

Ürün Kodu	Kısa Kod		Fiyat
AK.33.3604.P	13479	20	243.40



BORNOZ ASKILIĞI

Ürün Kodu	Kısa Kod		Fiyat
AK.44.3621.P	13486	20	143.40



UZUN HAVLULUK

Ürün Kodu	Kısa Kod	Uzunluk		Fiyat
AK.40.3614.P	13475	40 cm	20	290.00



YUVARLAK HAVLULUK

Ürün Kodu	Kısa Kod		Fiyat
AK.42.3617.P	13481	20	243.40



WC KAĞITLIK

Ürün Kodu	Kısa Kod		Fiyat
AK.34.3607.P	13480	20	176.70
AK.35.3608.P	13482	Kapaklı 20	226.70

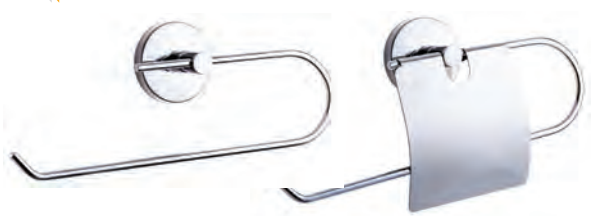

KAĞIT HAVLULUK

Ürün Kodu	Kısa Kod		Fiyat
AK.38.3612.P	13483	20	200.00
AK.39.3613.P	13485	Kapaklı 15	256.70

- Krom kaplama
- Prinç gövde

- SS 304 kalite paslanmaz kapak . Rozet ve çubuk
- Vakumlu



ETAJER

Ürün Kodu	Kısa Kod		Fiyat
AK.61.3501.P	26124	12	206.70



DİŞ FIRÇALIK

Ürün Kodu	Kısa Kod		Fiyat
AK.62.3504.P	26125	20	96.70



UZUN HAVLULUK

Ürün Kodu	Kısa Kod		Fiyat
AK.65.3514.P	26128	15	143.40



WC KAĞITLIK

Ürün Kodu	Kısa Kod		Fiyat
AK.67.3507.P	26130	20	96.70



SABUNLUK

Ürün Kodu	Kısa Kod		Fiyat
AK.63.3503.P	26126	16	100.00



BORNOZ ASKILIĞI

Ürün Kodu	Kısa Kod		Fiyat
AK.66.3527.P	26129	24	93.40



YUVARLAK HAVLULUK

Ürün Kodu	Kısa Kod		Fiyat
AK.64.3517.P	26127	15	120.00



WC KAPAKLI KAĞITLIK

Ürün Kodu	Kısa Kod		Fiyat
AK.68.3508.P	26131	20	120.00

- Krom kaplama
- Alüminyum gövde

- SS 430 kalite paslanmaz Rozet ve kapak
- Demir çubuk
- Blister Ambalaj



OVAL AYNA

Ürün Kodu	Kısa Kod		Fiyat
AK.94.4002.A	13499	54x74 cm 5	1253.40



LAVİ AYNA

Ürün Kodu	Kısa Kod		Fiyat
AK.90.4202.A	13501	40x50 cm 5	433.40



DİKDÖRTGEN AYNA

Ürün Kodu	Kısa Kod		Fiyat
AK.95.4102.A	13500	55x75 cm 5	1196.70



MİRA AYNA

Ürün Kodu	Kısa Kod		Fiyat
AK.91.4301.A	13502	40x50 cm 5	433.40
AK.92.4302.A	13503	40x60 cm 5	533.40
AK.93.4303.A	13504	50x70 cm 5	696.70



TEKLİ KÖŞE SÜNGERLİK

Ürün Kodu	Kısa Kod		Fiyat
AK.60.6018.S	32190	18x18 cm 10	220.00
AK.60.6018.G	32191	18x18 cm 10	220.00
AK.60.6018.B	32218	18x18 cm 10	220.00

- Plastik Lama
- Paslanmaz Tel



İKİLİ KÖŞE SÜNGERLİK

Ürün Kodu	Kısa Kod		Fiyat
AK.60.6118.S	32188	18x18 cm 10	440.00
AK.60.6118.G	32189	18x18 cm 10	440.00
AK.60.6118.B	32219	18x18 cm 10	440.00

- Plastik Lama
- Paslanmaz Tel



ÜÇLÜ KÖŞE SÜNGERLİK

Ürün Kodu	Kısa Kod		Fiyat
AK.60.6218.S	32226	18x18 cm 12	606.70
AK.60.6218.G	32227	18x18 cm 12	606.70
AK.60.6218.B	32228	18x18 cm 12	606.70

- Plastik Lama
- Paslanmaz Tel



TEKLİ KÖŞE SÜNGERLİK

Ürün Kodu	Kısa Kod		Fiyat
AK.61.6018.K	13509	18x18 cm 10	576.70

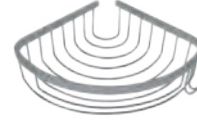

TEKLİ OVAL SÜNGERLİK

Ürün Kodu	Kısa Kod		Fiyat
AK.62.6519.K	13510	19x19 cm 10	600.00



İKİLİ KÖŞE SÜNGERLİK

Ürün Kodu	Kısa Kod		Fiyat
AK.61.6118.K	13512	18x18 cm 10	1026.70



İKİLİ OVAL SÜNGERLİK

Ürün Kodu	Kısa Kod		Fiyat
AK.69.6619.K	13513	19x19 cm 10	1183.40



ÜÇLÜ KÖŞE SÜNGERLİK

Ürün Kodu	Kısa Kod		Fiyat
AK.73.6218.K	13516	18x18 cm 12	1296.70

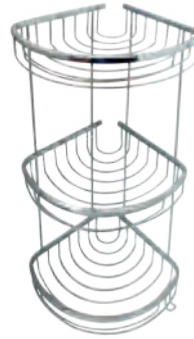

ÜÇLÜ OVAL SÜNGERLİK

Ürün Kodu	Kısa Kod		Fiyat
AK.254.6719.K	13515	19x19 cm 12	1503.40

OTOMATİK PLASTİK

Ürün Kodu	Kısa Kod	Yüzey	Ölçü	İkon	Fiyat
HD.01.4923.SM	13376	Şeffaf Mavi	27x22x36 cm	4	2406.70



OTOMATİK PLASTİK BEYAZ

Ürün Kodu	Kısa Kod	Yüzey	Ölçü	İkon	Fiyat
HD.01.4923.SB	26359	Beyaz	27x22x36 cm	4	2576.70



OTOMATİK PLASTİK KROM

Ürün Kodu	Kısa Kod	Yüzey	Ölçü	İkon	Fiyat
HD.01.4923.SK	13375	Krom	57x33x50 cm	4	3360.00



Z KATLI DİSPANSER 200'LÜK

Ürün Kodu	Kısa Kod	Yüzey	Ölçü	İkon	Fiyat
HD.03.4923.SM	13378	Şeffaf Mavi	23x21x9 cm	12	176.70



Z KATLI DİSPANSER 300'LÜK

Ürün Kodu	Kısa Kod	Yüzey	Ölçü	İkon	Fiyat
HD.02.4923.SM	30960	Şeffaf Mavi	26x29x11 cm	20	253.40
HD.02.4923.SY	30958	Siyah	26x29x11 cm	20	400.00





• Şeffaf manuel

JUMBO TUVALET KAĞIDI VERİCİ

Ürün Kodu	Kısa Kod	Yüzey	Ölçü	Fiyat
HD.06.4923.SM	30972	Şeffaf Mavi	Ø24x26 cm 20	250.00
HD.06.4923.SY	30970	Siyah	Ø24x26 cm 20	380.00



CİMRİ KAĞIT VERİCİ

Ürün Kodu	Kısa Kod	Yüzey	Ölçü	Fiyat
HD.08.4923.SM	30981	Şeffaf Mavi	Ø20 cm 20	233.40
HD.07.4923.SM	30978	Şeffaf Mavi	Ø25 cm 12	370.00
HD.07.4923.SF	30979	Şeffaf Füme	Ø25 cm 12	370.00
HD.07.4923.SY	30976	Siyah	Ø25 cm 12	466.70



MİNİ JUMBO KAĞIT VERİCİ

Ürün Kodu	Kısa Kod	Yüzey	Ölçü	Fiyat
HD.04.4923.SM	30966	Şeffaf Mavi	Ø21x24 cm 12	213.40



PLASTİK GÜLEN AĞIZ

Ürün Kodu	Kısa Kod	Yüzey	Ölçü	Fiyat
HD.11.4924.SY	30988	Siyah	29x41 cm 20	313.40



PLASTİK KÖPÜK VERİCİ

Ürün Kodu	Kısa Kod	Yüzey	Ölçü	Fiyat
HD.44.4715.SY	30954	Siyah	11x21x12 cm 15	363.40



SIVI SABUNLUK

Ürün Kodu	Kısa Kod	Yüzey	Kapasite	Fiyat
HD.35.4716.SM	13434	Şeffaf Mavi	500 ml 50	90.00
HD.37.4716.SM	13435	Şeffaf Mavi	1000 ml 50	146.70

ENVIRONMENTAL MANAGEMENT SYSTEM CERTIFICATE

Universal GmbH

This certificate is granted to the organization,

Mertinoks Yapı Malzemeleri Sanayi Ve Tic. AŞ.

Akcaburgaz Mah. 3073. Sok. No:4/3 Esenyurt/İstanbul/Türkiye

by review of IA2-2:7420 numbered report for the scope

Production, Sales and Marketing of Stainless Steel Wet Area Drains and Bathroom Accessories

to certify that a management system in accordance with standard's clauses is established and being implemented

DIN EN ISO 14001:2015

Certificate No : EMS 0722 009032
Original Certification Date : 01.07.2022
Issue / Revised Date : 01.07.2022
Expiry Date : 30.06.2023
Certification Period : 3 years (1*year)

IAF, DAKKS, UNICERT, Amibucan

ÇEVRE YÖNETİM SİSTEMİ SERTİFİKASI

Universal GmbH

Bu sertifika,

Mertinoks Yapı Malzemeleri Sanayi Ve Tic. AŞ.

Akcaburgaz Mah. 3073. Sok. No:4/3 Esenyurt/İstanbul/Türkiye kuruluşunun,

Paslanmaz Çelikten İslak Hacim Gidericileri ve Banyo Aksesuarları Üretim, Satış ve Pazarlama

Kapsamında, IA2-2:7420 sayılı raporadki inceleme ile

DIN EN ISO 14001:2015

standartının şartlarına uyarak bir yönetim sistemi kurduğunu ve uyguladığını onaylamak üzere verilmiştir.

Sertifika No : EMS 0722 009032
İlk Yayın Tarihi : 01.07.2022
Yayın / Revizyon Tarihi : 01.07.2022
Geçerlilik Tarihi : 30.06.2023
Belge Periyodu : 3 yıl (1. yıl)

IAF, DAKKS, UNICERT, Amibucan

QUALITY MANAGEMENT SYSTEM CERTIFICATE

Universal GmbH

This certificate is granted to the organization,

Mertinoks Yapı Malzemeleri Sanayi Ve Tic. AŞ.

Akcaburgaz Mah. 3073. Sok. No:4/3 Esenyurt/İstanbul/Türkiye

by review of IA2-2:7420 numbered report for the scope

Production, Sales and Marketing of Stainless Steel Wet Area Drains and Bathroom Accessories

to certify that a management system in accordance with standard's clauses is established and being implemented

DIN EN ISO 9001:2015

Certificate No : QMS 0722 009031
Original Certification Date : 01.07.2022
Issue / Revised Date : 01.07.2022
Expiry Date : 30.06.2023
Certification Period : 3 years (1*year)

IAF, DAKKS, UNICERT, Amibucan

KALİTE YÖNETİM SİSTEMİ SERTİFİKASI

Universal GmbH

Bu sertifika,

Mertinoks Yapı Malzemeleri Sanayi Ve Tic. AŞ.

Akcaburgaz Mah. 3073. Sok. No:4/3 Esenyurt/İstanbul/Türkiye kuruluşunun,

Paslanmaz Çelikten İslak Hacim Gidericileri ve Banyo Aksesuarları Üretim, Satış ve Pazarlama

Kapsamında, IA2-2:7420 sayılı raporadki inceleme ile

standartının şartlarına uyarak bir yönetim sistemi kurduğunu ve uyguladığını onaylamak üzere verilmiştir.

Sertifika No : QMS 0722 009031
İlk Yayın Tarihi : 01.07.2022
Yayın / Revizyon Tarihi : 01.07.2022
Geçerlilik Tarihi : 30.06.2023
Belge Periyodu : 3 yıl (1. yıl)

IAF, DAKKS, UNICERT, Amibucan

BENART SERTİFİKA CERTIFICATE

MERTİNOKS YAPI MALZEMELERİ SANAYİ VE TİCARET ANONİM ŞİRKETİ

ISO 45001:2018

PAŞLANMAZ ÇELİKLE İSLAK HACİM GİDERİCİLERİ VE BANYO AKSESUARLARI ÜRETİM, SATIŞ VE PAZARLAMA

PRODUCTION, SALES AND MARKETING OF STAINLESS STEEL WET AREA DRAINS AND BATHROOM ACCESSORIES.

TS EN 12054-1 / 16.02.2015

TÜRK STANDARLARI ENSTİTÜSÜ TÜRK STANDARLARINA UYGUNLUK BELGESİ

TURKISH STANDARDS INSTITUTION CERTIFICATE OF CONFORMITY TO TURKISH STANDARDS

0254730-TSE-0201

03.12.2019

27.01.2023

MERTİNOKS YAPI MALZEMELERİ SANAYİ VE TİCARET ANONİM ŞİRKETİ

AKCABURGAZ MAH. 3073. SK. /3 NO:4 ESENYURT İSTANBUL/TÜRKİYE

MERTİNOKS YAPI MALZEMELERİ SANAYİ VE TİCARET ANONİM ŞİRKETİ

AKCABURGAZ MAH. 3073. SK. NO:4 ESENYURT İSTANBUL / TÜRKİYE

TS 13385 / 29.04.2019

15.12.2021

27.01.2023

MERTİNOKS YAPI MALZEMELERİ SANAYİ VE TİCARET ANONİM ŞİRKETİ

AKCABURGAZ MAH. 3073. SK. /3 NO:4 ESENYURT İSTANBUL/TÜRKİYE

MERTİNOKS YAPI MALZEMELERİ SANAYİ VE TİCARET ANONİM ŞİRKETİ

AKCABURGAZ MAH. 3073. SK. NO:4 ESENYURT İSTANBUL / TÜRKİYE

TS EN 12054-1 / 16.02.2015

TÜRK STANDARLARI ENSTİTÜSÜ TÜRK STANDARLARINA UYGUNLUK BELGESİ

TURKISH STANDARDS INSTITUTION CERTIFICATE OF CONFORMITY TO TURKISH STANDARDS

0254730-TSE-0101

03.12.2019

27.01.2023

MERTİNOKS YAPI MALZEMELERİ SANAYİ VE TİCARET ANONİM ŞİRKETİ

AKCABURGAZ MAH. 3073. SK. /3 NO:4 ESENYURT İSTANBUL/TÜRKİYE

MERTİNOKS YAPI MALZEMELERİ SANAYİ VE TİCARET ANONİM ŞİRKETİ

AKCABURGAZ MAH. 3073. SK. NO:4 ESENYURT İSTANBUL / TÜRKİYE

TS 13385 / 29.04.2019

15.12.2021

27.01.2023

MERTİNOKS YAPI MALZEMELERİ SANAYİ VE TİCARET ANONİM ŞİRKETİ

AKCABURGAZ MAH. 3073. SK. /3 NO:4 ESENYURT İSTANBUL/TÜRKİYE

MERTİNOKS YAPI MALZEMELERİ SANAYİ VE TİCARET ANONİM ŞİRKETİ

AKCABURGAZ MAH. 3073. SK. NO:4 ESENYURT İSTANBUL / TÜRKİYE

TS EN 12054-1 / 16.02.2015

TÜRK STANDARLARI ENSTİTÜSÜ TÜRK STANDARLARINA UYGUNLUK BELGESİ

TURKISH STANDARDS INSTITUTION CERTIFICATE OF CONFORMITY TO TURKISH STANDARDS

0254730-TSE-0101

03.12.2019

27.01.2023

MERTİNOKS YAPI MALZEMELERİ SANAYİ VE TİCARET ANONİM ŞİRKETİ

AKCABURGAZ MAH. 3073. SK. /3 NO:4 ESENYURT İSTANBUL/TÜRKİYE

MERTİNOKS YAPI MALZEMELERİ SANAYİ VE TİCARET ANONİM ŞİRKETİ

AKCABURGAZ MAH. 3073. SK. NO:4 ESENYURT İSTANBUL / TÜRKİYE

TS EN 12054-1 / 16.02.2015

15.12.2021

27.01.2023

MERTİNOKS YAPI MALZEMELERİ SANAYİ VE TİCARET ANONİM ŞİRKETİ

AKCABURGAZ MAH. 3073. SK. /3 NO:4 ESENYURT İSTANBUL/TÜRKİYE

MERTİNOKS YAPI MALZEMELERİ SANAYİ VE TİCARET ANONİM ŞİRKETİ

AKCABURGAZ MAH. 3073. SK. NO:4 ESENYURT İSTANBUL / TÜRKİYE

TS EN 12054-1 / 16.02.2015

TÜRK STANDARLARI ENSTİTÜSÜ TÜRK STANDARLARINA UYGUNLUK BELGESİ

TURKISH STANDARDS INSTITUTION CERTIFICATE OF CONFORMITY TO TURKISH STANDARDS

0254730-TSE-0401

03.12.2019

27.01.2023

MERTİNOKS YAPI MALZEMELERİ SANAYİ VE TİCARET ANONİM ŞİRKETİ

AKCABURGAZ MAH. 3073. SK. /3 NO:4 ESENYURT İSTANBUL/TÜRKİYE

MERTİNOKS YAPI MALZEMELERİ SANAYİ VE TİCARET ANONİM ŞİRKETİ

AKCABURGAZ MAH. 3073. SK. NO:4 ESENYURT İSTANBUL / TÜRKİYE

TS EN 12054-1 / 16.02.2015

15.12.2021

27.01.2023

MERTİNOKS YAPI MALZEMELERİ SANAYİ VE TİCARET ANONİM ŞİRKETİ

AKCABURGAZ MAH. 3073. SK. /3 NO:4 ESENYURT İSTANBUL/TÜRKİYE

MERTİNOKS YAPI MALZEMELERİ SANAYİ VE TİCARET ANONİM ŞİRKETİ

AKCABURGAZ MAH. 3073. SK. NO:4 ESENYURT İSTANBUL / TÜRKİYE

TS EN 12054-1 / 16.02.2015